Senior Leader Perspective

Taming the Tigers | 4

Recapturing the Acquisition Excellence of Our Planning, Programming, and Acquisition Three-Ring Circus

Maj Gen Robert Kane, USAF
Lt Col Jason Bartolomei, PhD, USAF

Features

The Air War in Libya | 28

Maj Jason R. Greenleaf, USAF

A Case for Air Force Reorganization | 55

Col Jeffrey P. Sundberg, USAF

A New Approach to Ballistic Missile Defense for Countering Antiaccess/ Area-Denial Threats from Precision-Guided Weapons | 83

Col Mike Corbett, USAF, Retired

Realizing Operational Planning and Assessment in the Twenty-First-Century Air Operations Center | 107

How a Refined Planning Construct and Semantic Technologies Can Enable
Delivery of the AOC's Last Unsupported Functions (Part 1)

Wg Cdr Redvers T. Thompson, Royal Air Force, Retired

Airmen and Mission Command | 131

Lt Col James W. Harvard, USAF, Retired

Departments

147 | Views

Observations on the Air War in Syria 147

Lt Col S. Edward Boxx, USAF

169 | Book Reviews

- Cataclysm: General Hap Arnold and the Defeat of Japan 169
Herman S. Wolk
Reviewer: Frank Kalesnik, PhD
- Navy Strategic Culture: Why the Navy Thinks Differently 171
Roger W. Barnett
Reviewer: Toby Lauterbach
- Fighting Talk: Forty Maxims on War, Peace, and Strategy 174
Colin S. Gray
Reviewer: Maj Stephen L. Meister, USAF
- Breakthrough: The Gorlice-Tarnow Campaign, 1915 176
Richard L. DiNardo
Reviewer: Gilles Van Nederveen
- Terrorism, Instability, and Democracy in Asia and Africa 178
Dan G. Cox, John Falconer, and Brian Stackhouse
Reviewer: Mel Staffeld
- Confronting the Chaos: A Rogue Military Historian
Returns to Afghanistan 180
Sean M. Maloney
Reviewer: Capt William R. Giles, USAF
- Bully Able Leader: The Story of a Fighter-Bomber
Pilot in the Korean War 182
Lt Gen George G. Loving, USAF, Retired
Reviewer: Dr. Dan Mortensen

Editorial Advisory Board

Gen John A. Shaud, PhD, USAF, Retired, *Air Force Research Institute*
Lt Gen Bradley C. Hosmer, USAF, Retired
Dr. J. Douglas Beason (Senior Executive Service and Colonel, USAF, Retired), *Air Force Space Command*
Dr. Alexander S. Cochran, *Office of the Chief of Staff, US Army*
Prof. Thomas B. Grasse, *US Naval Academy*
Lt Col Dave Mets, PhD, USAF, Retired, *School of Advanced Air and Space Studies (professor emeritus)*

Board of Reviewers

Dr. Kendall K. Brown
NASA Marshall Space Flight Center

Dr. Clayton K. S. Chun
US Army War College

Dr. Mark Clodfelter
National War College

Dr. Conrad Crane
Director, US Army Military History Institute

Col Dennis M. Drew, USAF, Retired
USAF School of Advanced Air and Space Studies
(professor emeritus)

Maj Gen Charles J. Dunlap Jr., USAF, Retired
Duke University

Dr. Stephen Fought
USAF Air War College (professor emeritus)

Col Richard L. Fullerton, USAF
USAF Academy

Lt Col Derrill T. Goldizen, PhD, USAF, Retired
Westport Point, Massachusetts

Col Mike Guillot, USAF, Retired
Editor, *Strategic Studies Quarterly*
Air Force Research Institute

Dr. John F. Guilmartin Jr.
Ohio State University

Dr. Amit Gupta
USAF Air War College

Dr. Grant T. Hammond
USAF Center for Strategy and Technology

Dr. Dale L. Hayden
Air Force Research Institute

Mr. James Hoffman
Rome Research Corporation
Milton, Florida

Dr. Thomas Hughes
USAF School of Advanced Air and Space Studies

Lt Col Jeffrey Hukill, USAF, Retired
Curtis E. LeMay Center for Doctrine Development
and Education

Lt Col J. P. Hunerwadel, USAF, Retired
LeMay Center for Doctrine Development and Education

Dr. Mark P. Jelonek, Col, USAF, Retired
Aerospace Corporation

Col John Jogerst, USAF, Retired
Navarre, Florida

Mr. Charles Tustin Kamps
USAF Air Command and Staff College

Dr. Tom Keaney
Johns Hopkins University

Col Merrick E. Krause, USAF, Retired
Department of Homeland Security

Col Chris J. Krisinger, USAF, Retired
Burke, Virginia

Dr. Benjamin S. Lambeth
Center for Strategic and Budgetary Assessments

Mr. Douglas E. Lee
Air Force Space Command

Dr. Richard I. Lester
Eaker Center for Professional Development

Mr. Brent Marley
Redstone Arsenal, Alabama

Mr. Rémy M. Mauduit
Air Force Research Institute

Col Phillip S. Meilinger, USAF, Retired
West Chicago, Illinois

Dr. Daniel Mortensen
Air Force Research Institute

Dr. Richard R. Muller
USAF School of Advanced Air and Space Studies

Dr. Bruce T. Murphy
Air University

Col Robert Owen, USAF, Retired
Embry-Riddle Aeronautical University

Lt Col Brian S. Pinkston, USAF, MC, SFS
Civil Aerospace Medical Institute

Dr. Steve Rothstein
Colorado Springs Science Center Project

Lt Col Reagan E. Schaupp, USAF
Naval War College

Dr. Barry Schneider
Director, USAF Counterproliferation Center
Professor, USAF Air War College

Col Richard Szafranski, USAF, Retired

Lt Col Edward B. Tomme, PhD, USAF, Retired
CyberSpace Operations Consulting

Dr. Christopher H. Toner
University of St. Thomas

Lt Col David A. Umphress, PhD, USAFR, Retired
Auburn University

Col Mark E. Ware
Twenty-Fourth Air Force

Dr. Harold R. Winton
USAF School of Advanced Air and Space Studies



Taming the Tigers

Recapturing the Acquisition Excellence of Our Planning, Programming, and Acquisition Three-Ring Circus

Maj Gen Robert Kane, USAF*

Lt Col Jason Bartolomei, PhD, USAF

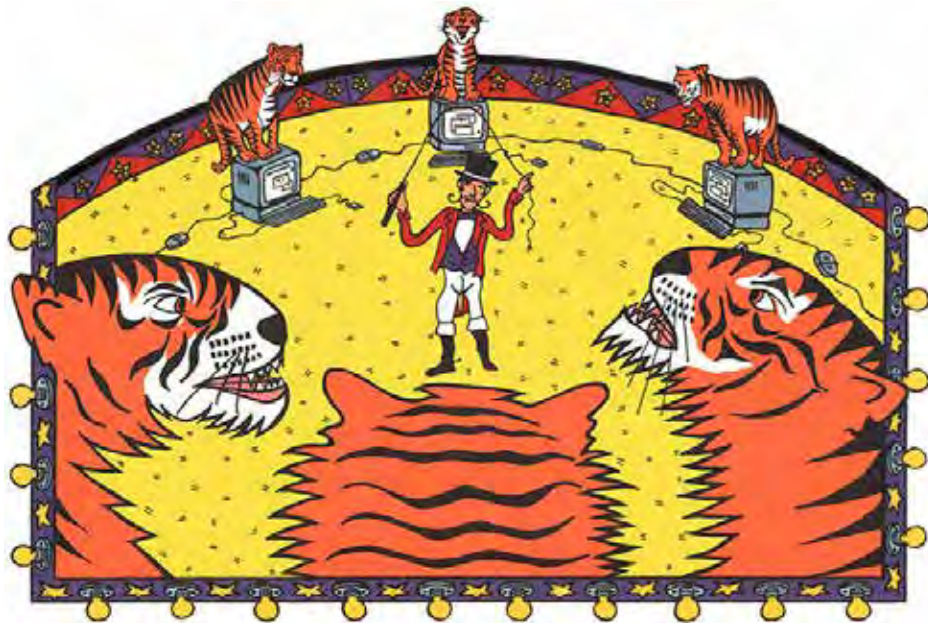

We in the Air Force have adopted an approach that suboptimizes our Big “A” acquisition triad of requirements, budget, and acquisition processes and that lacks a sufficient “trade space” analysis to maximize the benefit of our dollars. *Trade space*, which combines the terms *trade-off* and *play space*, refers to the lead-

Illustration reprinted by permission of Michael Brewer, www.michaelbrewerart.com.

*The authors would like to thank the following individuals for their incisive thinking and constructive edits: Gen Jim McCarthy (retired), Prof. Dan Hastings, Prof. Richard de Neufville, Prof. Gautam Mukunda, Col Glenn Downing, Col Chris Garrett, Col Jim Lovell, Col Troy Thomas, Bill Castle, Mike Kalna, Carl Rehberg, Nic Wilson, Lt Col Darren Cochran, Lt Col Luke Cropsey, Lt Col Vinnie Dabrowski, Lt Col Rick Holifield, Lt Col Pete Sandness, Lt Col Mike Warner, Maj Nate Campbell, Maj Jens Lyndrup, Maj Dan Mollis, Maj Dan Pupich, Maj Jon Seal, Dr. Kevin Sweeney, Dr. Matt Richards, Dr. Donna Rhodes, Dr. Adam Ross, Dr. Nirav Shah, Dr. Tom Speller, Paul Bess, Frank Finelli, Marcus Friesen, and Matt Jensen.



er's options and the consideration of the advantages and disadvantages of those choices. The objective of considering the trade space is to expand the envelope of potential options to identify the best alternative. Failures to develop our trade space have diluted the quality and timeliness of decision making by the secretary of the Air Force and the chief of staff. Our core problem involves a systemic failure to create trade spaces that integrate the information used in our separate planning, budgeting, and acquisition processes to holistically inform the Air Force's decisions. The inability to successfully integrate these processes creates programmatic instabilities that lead to cost and schedule overruns, reinforces political vulnerabilities which undermine our ability to implement a path forward, and, ultimately, limits our capacity to maximize delivery of war-fighting value.

This situation is of particular concern as we face a significant budget crisis and imminent reductions in defense spending. Figure 1 illustrates this point by presenting a notional "benefit versus cost" chart that defines value as benefit at cost. Our fear is that, for the amount of money we spend on our Air Force, we are not maximizing the benefit. If we continue on our current path, we run the risk of diminishing our capabilities at a time when we face increasingly compelling and diverse security issues that will undoubtedly require a full range of leading-edge air, space, and cyber capabilities.¹ Reversing these effects demands new thinking and a new approach.

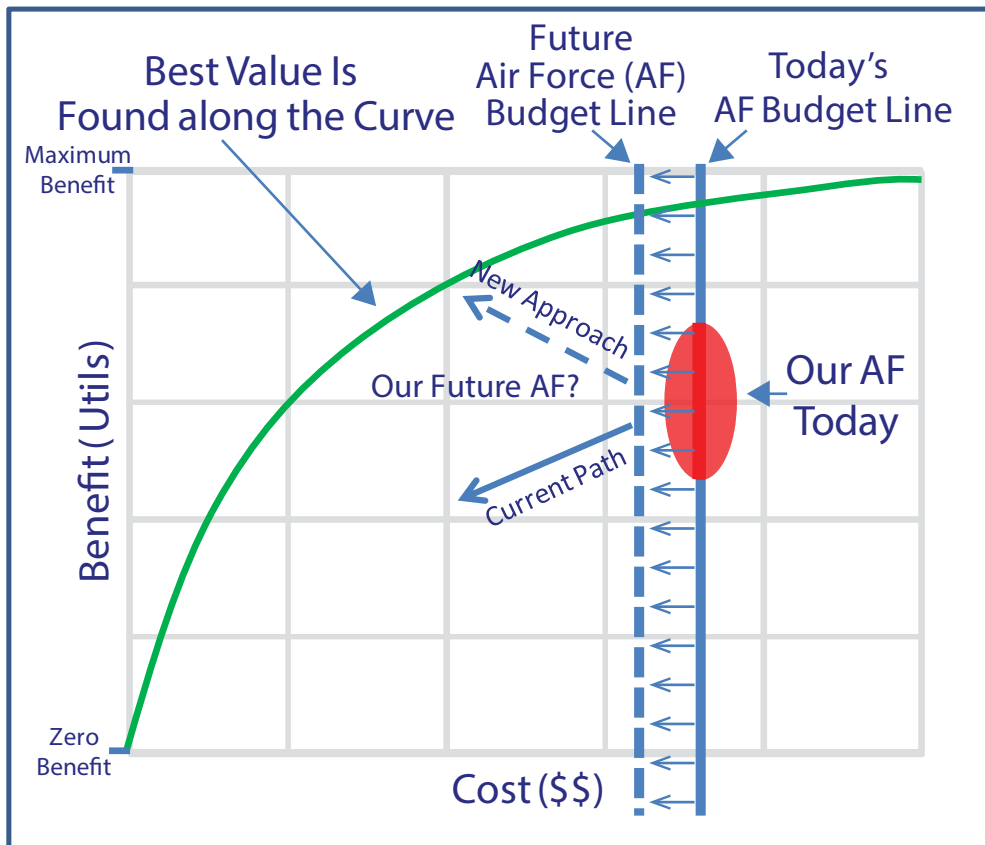

Figure 1. Value chart (benefit versus cost)

A more effective option entails a holistic, value-focused approach that expands visibility into our decision trade space by identifying alternatives that maximize our capabilities and budgets while capitalizing on the strengths of our established processes. This new approach would take advantage of the best information available in our planning, budgeting, and acquisition processes and allow Air Force leaders to simultaneously assess the assumptions, costs, benefits, and alternatives of decisions and expand the trade-off between benefit and cost. We can use this scalable approach to explore strategic-level trade-offs at the capabilities or mission-requirements level of analysis, as well as trade-offs for particular systems and programs. Furthermore, this approach enables necessary justification and means for demonstrating to



the Office of the Secretary of Defense and the congressional staffs the clear basis for Air Force investments. Toward that end, this article first reviews the Air Force's current Big "A" acquisition process and then compares it to how other large organizations have successfully addressed similar challenges involving prioritization and trade-space analysis. In conclusion it presents a new, value-driven approach tailored to integrate our processes and improve our ability to deliver value-maximizing solutions.

The Current Air Force Process: Our Tigers and the Three Rings

The Air Force's Big "A" acquisition processes, like the Department of Defense's (DOD), consists of three "interlocking" decision support systems (fig. 2), including the following:

- Core function lead integrators (CFLI), led by commanders of the major commands (MAJCOM), are responsible for identifying, assessing, and prioritizing the Air Force's capability needs. CFLIs, along with the Air Force-level requirements process, define and transform war-fighting needs for the 12 Air Force core functions (soon to be 13 with the addition of education and training) into prioritized investment, sustainment, and divesture recommendations for the Air Force corporate structure (AFCS). The role of the CFLI continues to evolve.
- The AFCS, which executes the Planning, Programming, Budgeting, and Execution (PPBE) process, consists of three distinct but inter-related phases: (1) planning, which produces Air Force planning guidance; (2) programming, which produces the service's program objective memorandum (POM); and (3) budgeting, which produces the Air Force's portion of the president's budget.² The AFCS is chaired and led by the undersecretary of the Air Force / vice chief of staff of the Air Force and managed by the Directorate of Strategic Plans and Programs. The AFCS transforms the CFLIs' invest-

ment and the MAJCOMs' inputs regarding operation and maintenance, as well as programmatic data provided by the Air Force Acquisition System, into a recommended POM submission for consideration by and approval of the secretary and chief of staff. Once approved, the POM becomes the service's budget input.

- The Air Force Acquisition System executes the Defense Acquisition System (DAS) process to acquire systems to support war-fighter requirements through engaging with appropriate industry partners and determining responsive business solutions. The service acquisition executive leads the system, which is executed through the program executive officer structure and organized, trained, and equipped by Air Force Materiel Command's organizational structure. The system transforms requirements defined by the Joint Capabilities Integration and Development System (JCIDS) and budget allocated by the PPBE system into materiel for the war fighter. Most importantly, in conjunction with the requirements owners and processes, the service acquisition executive and the acquisition process—in transparent and open communication with industry partners—are best positioned to fully explore, develop, and communicate the potential trade-space options available to the secretary and chief of staff for modernization and recapitalization, including the impacts over total life-cycle costs.

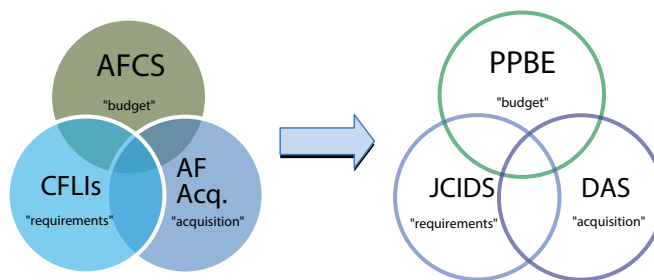

Figure 2. The Air Force's acquisition decision support systems (left) mirror those of the Department of Defense (right).

Organizationally, responsibilities are distributed across the Air Force enterprise (fig. 3). Each organization converts information, dollars, and/or material into products used by the other organizations. The article briefly examines each system in turn.



Figure 3. The Air Force's acquisition enterprise

Figure 4 illustrates how information, money, and materiel currently flow across each system. CFLIs (top left) provide a prioritized list of requirements for each of the Air Force core functions. Moreover, CFLIs must formulate requirements and formally present them by means of the JCIDS process to the Air Force Acquisition System in the form of requirements documentation. The AFCS prioritizes the CFLIs' requirements lists along with programmatic data provided by the acquisition system and develops the Air Force POM, which ultimately becomes the president's budget. After Congress approves the budget, the acquisition system executes it through obtaining weapon systems that meet requirements recommended by the CFLI and approved by the secretary and chief of staff.

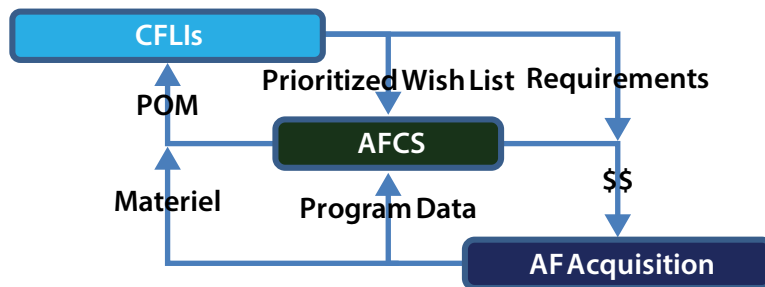

Figure 4. Interactions across the Air Force’s acquisition decision support systems

For the Air Force, maximizing value is difficult because of the absence of a shared common value proposition and the fragmentation of elements for calculating value across these processes. Each process is locally optimized to generate its desired products/capability and does not effectively communicate in ways that necessarily maximize value or create options for both the service and the war fighter. This situation occurs because the ingredients for determining value (e.g., the formation of alternatives, assessment of benefit, calculation of costs, and characterization of constraints) occur in different systems and are driven by different incentives. Each system operates with its own set of assumptions and constraints, producing isolated, unintegrated communication documents not timed to affect each other’s decision process. The sections below synthesize our findings.

Developing Alternatives

CFLIs, the AFCS, and Air Force Acquisition discuss alternatives in different terms. Planners think in terms of solution systems (system A versus system B). Acquisition thinks in terms of designs, production rates, contract types, and modification options. Programmers think in terms of dollar amounts. Leaders at all levels of the Air Force have an insufficient trade space of alternatives for most decisions. The norm usually consists of sets of three alternatives: (1) an overly optimistic solution, (2) an overly pessimistic solution, and (3) a solution that the staff wants the boss to choose. Each process produces an indepen-



dently developed list of alternatives that are rarely exhaustive or coordinated across the other decision support systems. Furthermore, these alternatives are usually presented too late in the process, with weak business case analyses, and frequently in a binary decision form. Often this means that suboptimal decisions remain vulnerable to politics or other pressure which influences or redirects Air Force decisions.

Assessing Benefit

Each process calculates benefit differently. CFLIs must “watch over” the service core functions and assess benefit in accordance with the core function master plans. CFLIs measure success in terms of securing the percentage of total obligation authority necessary to fulfill the master plans with the lowest risk sought by the MAJCOM. After defining the operational requirement and signing the acquisition decision memorandum, Air Force Acquisition measures success in terms of its ability to execute the program and spend all of the budget. Program managers have virtually no incentive to support trade-offs between platforms outside their portfolio or embark upon moves to cut or cancel ill-fated programs under their control. Moreover, thousands of acquisition man-hours are devoted to assessing program execution, moving unobligated funds, and obligating funds to ensure that every dollar is spent.³ This occurs with a focused lens on the original (often dated) operational requirements and limited attention to current or emerging military needs. Success in the AFCS comes from balancing the books and maximizing the Air Force’s total obligation authority necessary to conduct the mission. Collectively this approach can result in costly and detrimental trade-off decisions that affect the development of necessary war-fighting capability in a rapidly changing world, thereby impeding our ability to satisfy the long-term strategic interests and policies of the Air Force, DOD, and nation.



Calculating Cost

The service uses cost (not value) as a primary driver of programmatic decisions. Each process is concerned with cost but uses different methods and sources for different reasons. The Air Force Cost Analysis Agency; acquisition financial-management offices; Office of the Secretary of Defense's Cost Assessment and Program Evaluation; Analyses, Assessments, and Lessons Learned; and Strategic Plans and Programs often develop diverging cost estimates using different costing methods and sources. At present, the CFLIs do not calculate costs in their prioritization of requests. The Air Force Acquisition System supplies cost data to inform both the CFLIs' and the AFCS's decisions. Too often we overemphasize limitations of the Future Years Defense Program as opposed to building internal and external consensus on long-term vision and priorities.

Timing

Each process operates on its own unique decision cycle, not synchronized with other processes. For example, leaders from planning and programming processes have no involvement in acquisition until after acquisition strategies are set and budgets committed. Consequently, expensive programs with questionable or unsupportable strategies can reach key milestones ahead of senior leaders' consensus on the best approach. Planners often define requirements for the most advanced technical solutions without the participation of programmers and acquisition professionals who understand resource constraints and know about lower-risk solutions that might offer better value.

For a systematic process to operate in concert throughout the Air Force, information from these independent processes must share a value proposition and a common means to evaluate benefits and costs. Each decision must begin with a definitive articulation of our stakeholders and the basis for calculating the value that we expect the decision to deliver. Underlying assumptions for calculating both benefit and cost must be integrated and transparent to all parties evaluating



the alternatives. Leaders must have this information at the appropriate times throughout the Air Force's decision cycle. Responsible for the primary mission of the Air Staff and its associated processes, decision makers should receive the broadest set of alternatives and intuitively determine the trade-offs between benefits and cost. In short, our systems and the MAJCOM commanders' recommendations must maximize the secretary's and chief's decision trade space.

How the Other "Big Guys" Do It

The quest for new ideas led us to research how some top-10 *Fortune* 500 corporations and other globally focused, multicapable military forces execute a successful process to link and streamline requirements, budgeting, and acquisition. We analyzed each company's annual report to shareholders and conducted interviews with Wall Street analysts as well as leading professors and military-reform experts; we then compared our findings with an analysis of the Air Force process. Despite fundamental differences between the mission of a corporation and a military service, we found many similarities and useful insights to help stimulate our thinking.

The large corporations that we analyzed reflected an organizational scheme similar to that of the Air Force. Each one had hierarchical management structures consisting of a corporate staff (like our Air Staff) and major business units (like our MAJCOMs). These corporations sought to maximize value (the perceived and actual benefit at cost) to its stakeholders (those who affect or are affected by the organization's actions). All of the corporations set a central goal of maximizing stakeholder value. As such, the vital linkage between corporate decision making (i.e., selling business units to cut costs, adding or reducing personnel, executing bold initiatives, and allocating budget) and delivering value was paramount to the success of the firm. In each one, we found critical alignment between the localized goals of each business unit and the global goal of the corporation, as well as a careful balance between short-term gain and long-term objectives. This ap-



proach starkly contrasts that of the DOD. Ken Krieg, former undersecretary of defense for acquisition, technology and logistics, explains the difference between industry and the DOD:

In the private sector, if you make a decision to invest capital, particularly a sizeable decision to invest capital, that goes all the way to the chairman and probably to the board if it's a reasonable amount. . . . Everyone within the company—directors of the manufacturing, marketing, sales, finance and other departments—agrees to the decision and commits to making it work.

Not so in the government . . . where a tremendous number of stakeholders often work toward contradictory goals, and year-to-year budget fluctuations can derail an initiative before it's able to bear fruit.⁴

Additionally, we found a common theme concerning the challenge of delivering value over time. Each firm described the uncertainty of the future and its efforts to manage risks and take advantage of opportunities. They cited their use of data, advanced analytics, and forecasts to inform near-term as well as long-term decisions. In many cases, the latter were tied to a well-defined vision and measured in decades. We were particularly impressed with ExxonMobil's approach: "We carefully assess investments over a range of potential market conditions and across time horizons that can span decades. Our approach to investing is to advance only those opportunities that are likely to provide long-term shareholder value."⁵

Corporations possess a clear advantage in one key area—their superior accounting practices and tools.⁶ They use the latter as both management and communication devices that enable them to assess value, align internal interests, communicate decisions internally and externally, and integrate management systems in ways not currently possible in the DOD. Undersecretary Krieg explains that "for-profit companies also have a concrete way to measure their efforts, based on the bottom line. . . . That's not as simple within DoD . . . where effectiveness is measured not by numbers on a spread sheet, but by capability."⁷

Although many differences exist between corporate and government decision making, the need to successfully link and streamline decision support processes remains universally important. Thus, the Air Force



must develop better ways to calculate and communicate stakeholder value and develop a more complete guidance or picture of the “overall and cross-portfolio” trade space.

Taming the Tigers through Trade-Space Exploration

Several management and analytical approaches can support organizational decision making. Economics, marketing, and finance-centric approaches dominate the analytical landscape. However, most of them are tailored for business and cannot be easily imported into government acquisition. The requirement needs include (1) an approach that provides transparency of assumptions and constraints, (2) a method to simultaneously evaluate the costs and benefit of decisions not often measured in dollars, and (3) the means to examine broader sets of alternatives over multiple scenarios and to allow decision makers to visualize and interact with the data that supports their decisions.

The academic world recognizes that the complexity of today’s technology, management, and policy issues calls for new thinking that transcends traditional disciplinary stovepipes in the engineering, management, and policy fields.⁸ Researchers at the Massachusetts Institute of Technology’s Engineering Systems Division are leading the way in developing various new tools and techniques tailored for these vexing problems. These scholars combine the best tools from marketing, finance, political science, and engineering to inform the development of a complex decision-making environment. In particular, a team of researchers has developed an approach that meets our requirement needs—one that allows leaders to simulate the benefits and costs of strategic decisions and to visualize this data over time and across scenarios.⁹ Their approach permits decision makers to evaluate large trade spaces with hundreds, even thousands, of alternatives. This intuitive method, which we can tailor for our purposes, includes the following steps:



1. Define the problem, scenario, or resource decision with corresponding assumptions.
2. Define the stakeholders.
3. Define the assessment of benefits and costs.
4. Develop a set of possible alternatives.
5. Calculate/estimate the cost and benefit for each alternative and explore the trade space.
6. Repeat steps one through five for alternate scenarios or assumptions.

In the DOD, one may consider US Transportation Command (USTRANSCOM) a good example of a highly complex military organization that truly understands maximizing value to the war fighter and the nation. From its inception in the late 1980s and accelerating in the early and mid-1990s, USTRANSCOM has evolved and improved its forces, programs, planning, and operations to optimize transportation capabilities. In doing so, the command ensures that it continues to satisfy its current supporting mission and future contingency plans in a cost-efficient yet wholly effective manner.¹⁰

To illustrate the above-mentioned method, we present a notional case example from USTRANSCOM to examine the operational/military utility and business-case analysis of multimodal transportation decision making in response to a high-priority operational military requirement. This represents an operational-level but not a strategic-level example. Consequently, we have simplified the calculation of benefit, costs, and definition of alternatives. The case study offers a step-by-step procedure illustrating a possible application of our proposed analytical method.

Step 1. Define the Problem, Scenario, or Resource Decision with Corresponding Assumptions

The proposed method begins by identifying the core underlying problem or resource decision that must be made and the corresponding as-



sumptions. In the summer of 2007, the secretary of defense tasked USTRANSCOM's leadership to transport 3,500 of the latest mine-resistant ambush-protected (MRAP) vehicles to Iraq and Afghanistan by year's end. To meet the secretary's intent, those leaders must design a plan that meets this goal within resource constraints.

Step 2. Define the Stakeholders

The key stakeholders in this scenario include, but are not limited to, USTRANSCOM, Air Mobility Command, Military Sealift Command, airlift contractors, sealift contractors, the secretary of defense, and US Central Command.

Step 3. Define the Assessment of Benefits and Costs

Each stakeholder currently possesses its own unique benefit equation and preferences for addressing the proposed problem. In most cases, benefit is neither formally defined nor shared with the other stakeholders. The process of developing a common understanding of benefit drives alignment between the various stakeholders involved in the system. For this scenario, we assume that the stakeholders defined the key criteria (attributes) in the benefit calculation as follows:

- response time: measured in the average number days to deliver an MRAP to an operational unit
- capacity: measured in the number of MRAPs delivered per month
- impact to other operations: qualitative measure based on a five-point scale (0 = minimal impact, 3 = moderate impact on other missions, 5 = disruption of critical higher-priority missions)

Each attribute is weighted based on what the stakeholders perceive as benefiting them. Determining actual weights for the attributes can prove time consuming. The academic literature includes a variety of methodologies available to derive these weights analytically.¹¹ Albeit challenging, the process for determining these weights will pay off in the long run. For simplicity's sake, we assume that the attribute "re-



response time” had a value twice as important as the other criteria. Next, we must specify the assessment of cost—specifically, in this case study, as the average cost to deliver one MRAP.

Step 4. Develop a Set of Possible Alternatives

Development of a robust set of alternatives can present a vexing challenge. Here, such a set would include varying levels of military airlift, commercial airlift, military sealift, commercial sealift, and many combinations for each. To keep things simple, we first consider a set of three possible alternatives—(1) use airlift, (2) use sealift, or (3) use a combination of the two—and then assess the benefits and cost for each (see table).

Table. Assessment of alternatives

	Importance	Airlift	Sealift	Air Lift + Sealift
Response Time (Avg. Days to Delivery)	0.5	1 day	25 days	3 days
Capacity (Number of MRAPs Delivered per Month)	0.25	360	>500	>500
Impact to Other Missions (Low to High)	0.25	Moderate	Low	Low
Cost (Avg. Cost to Deliver 1 MRAP)		\$135K	\$18K	\$50K

Step 5. Calculate/Estimate the Cost and Benefit for Each Alternative and Explore the Trade Space

From the table, we now have the necessary information to analyze the alternatives. In order to perform the calculation, we normalized the variables in the table. We then multiplied these normalized values by the importance column and plotted the sums of these now-weighted values for each alternative in figure 5. Because we have evaluated all of them in terms of the same value metrics, we can perform an “apples to apples” comparison. Due to the risk associated with both the benefit and cost estimations, the data points are really ellipses that represent this uncertainty—the greater the uncertainty, the larger the ellipse.

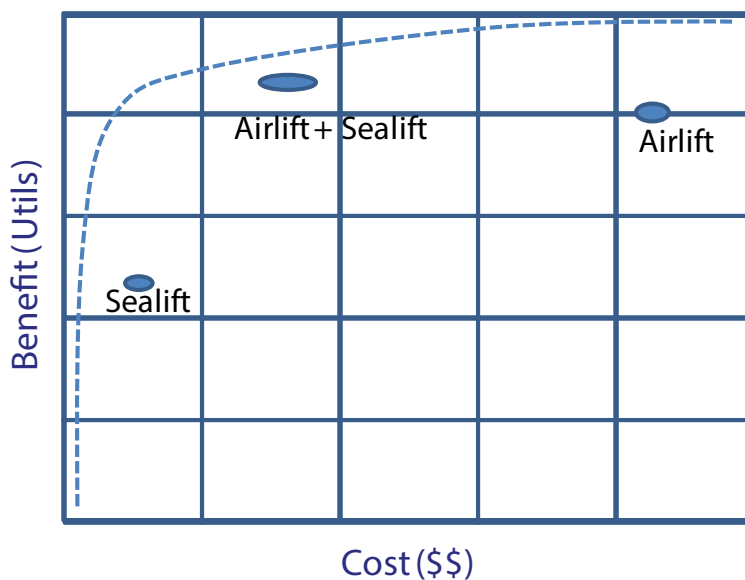

Figure 5. Plotting the benefit versus cost for the alternatives

We see that combining airlift and sealift conveys the best value by delivering significantly more benefit (measured in utils or the weighted average of the benefit criteria) than both the airlift-only and sealift-only alternatives. We now have the making of a trade space of alternatives to compare options and think critically about how best to move forward. The next question is, “Are there even better value alternatives that simultaneously improve operational effectiveness at a lower cost?”

Over the past 20 years, computer modeling and simulation have greatly aided the task of developing alternatives. Figure 6 is an example of a large trade-space product using the approach developed by researchers at MIT. Using their methods, we can generate large sets of alternatives through modeling and simulation. Each alternative is plotted according to its assessed benefit and cost, using the criteria defined above. The “best” alternatives, represented by the dotted line in figures 5 and 6, cannot be improved in one dimension (benefit) without worsening in the other dimension (cost), a phenomenon referred to as the

Pareto efficient frontier. The most interesting region in the trade space, the Pareto frontier represents alternative solutions that provide the “best bang for the buck.” In our case study, the analysis suggests that potentially less expensive options meet the benefit generated by the combination of airlift and sealift. Other solutions below the airlift and sealift alternative are inefficient.

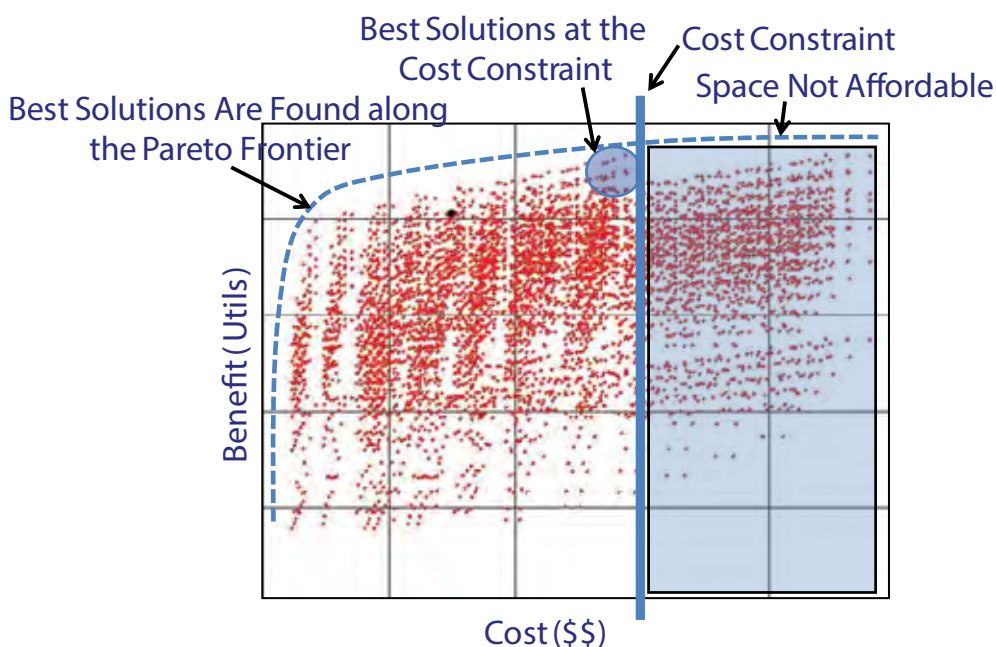

Figure 6. A notional-value trade space with thousands of alternatives

Step 6. Repeat Steps One through Five for Alternate Scenarios or Assumptions

Because the future is uncertain, forecasts are almost always wrong, and participating stakeholders often carry divergent assumptions. Nevertheless, it is possible to examine the same trade spaces of alternatives under different assumptions regarding benefits and costs (e.g., differing customers and alternative futures).¹² For example, what if the secretary of defense updates his guidance or changes his weights for

the criteria? We could easily recalculate the trade space to account for these changes or other alterations to the assumptions. Figure 7 represents a trade space examined by using 16 scenarios with varying sets of assumptions.

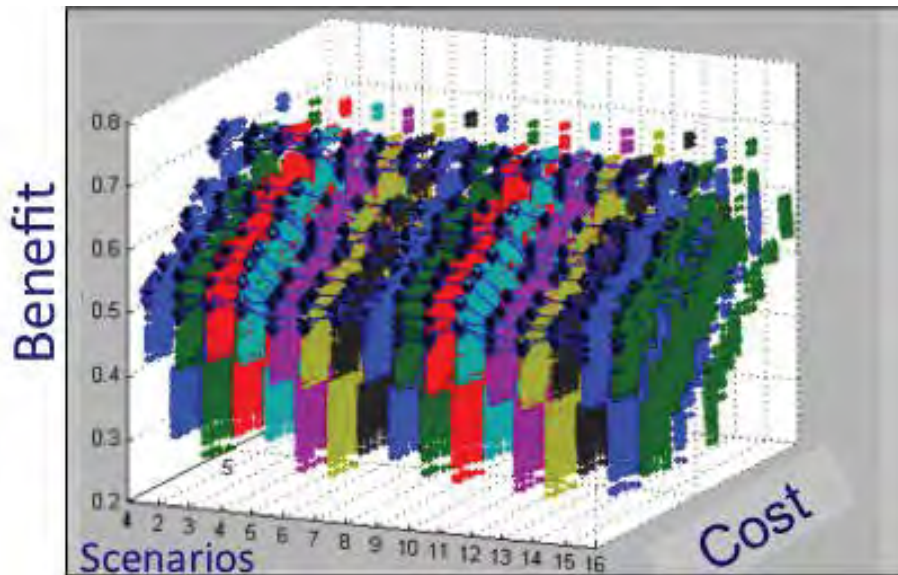

Figure 7. Value trade spaces with varying scenarios

We are particularly interested in alternatives that perform well (located on or near the Pareto frontier) across many scenarios. They are “value robust” because of their insensitivity in benefit per cost to changes across considered scenarios.¹³ In light of the severe uncertainty we face, analytical tools for identifying valuable solutions across alternative scenarios would prove helpful.

In our case study, we presented a representative problem from the war-fighting domain to review the method and demonstrate how to expand the trade space, balance operational necessity with business-case analysis, and translate it into executable public policy. In the MRAP example, we constrained our discussion to the USTRANSCOM commander’s operational/execution trade space. We could have added much



greater complexity with constraints such as geopolitics or natural disasters—factors with which USTRANSCOM also deals frequently and globally. Our point is not to use MRAP as an example of acquisition reform but to highlight how we can use the “tailored” method to determine modernization and operational (doctrine, organization, training, materiel, leadership and education, personnel, and facilities) trade-space alternative solutions by bringing value to the services, capacity to the war fighter, and facilitating the good execution of public policy. The next section examines how this approach can better integrate decision making across our planning, programming, and acquisition processes.

Operational Blueprint to Adopt a Value-Driven Approach

An operational blueprint begins with development of a long-term vision for the Air Force and a clear articulation of value based on US policy and requirements of the combatant command. Leadership must translate these needs into benefit calculation(s) that can evaluate decisions. This is no easy task because it requires our leaders to define and share a collective (within the Air Force, Office of the Secretary of Defense, and Congress) understanding of how benefit will be defined for the Air Force. Then leaders must work together to develop robust, innovative sets of alternatives for consideration. These include alternatives at the Air Force (across core functions), core-function, mission-requirement, and system levels. Finally, our leaders must provide a common framework for calculating and evaluating costs. The process to construct a value-driven trade space demands timely participation and close collaboration between the leaders and staffs of our three rings (fig. 8). The arrows notionally represent the source of the information. Arrows emanating from overlapping circles indicate that leaders and staffs from the respective processes must collaborate to supply the requisite information.

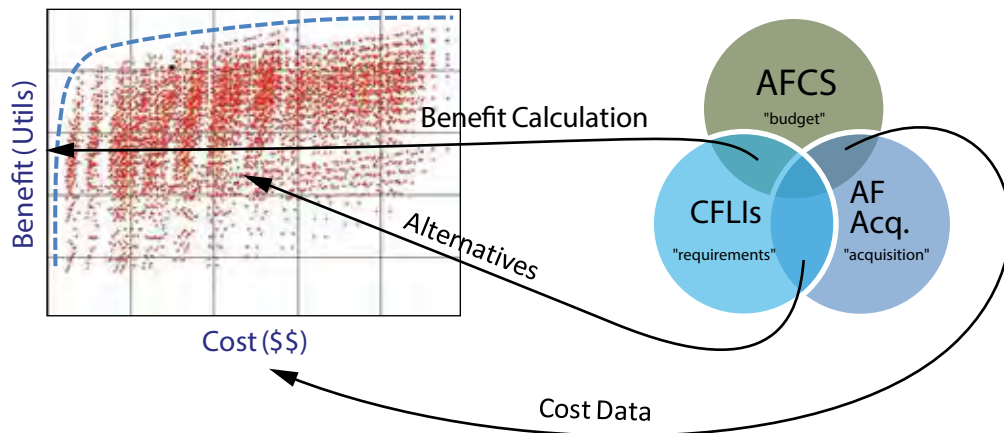

Figure 8. Inputs to the value trade space

Next, we must integrate and synchronize the trade-space analysis within the Air Force's decision cycle, which consists of calendar-driven and process-driven decision-making events. These include the annual four-star-level meetings called CORONAs as well as other meetings that occur in support of planning, programming, and acquisition decisions.

We recommend that an agency such as Air Force Analyses, Assessments, and Lessons Learned serve as an independent agent to gather the data and perform the analysis. It would have responsibility for coordinating and leading analytical efforts to link and streamline analyses to support the milestones for each process, with the goal of providing leaders across the Air Force enterprise a common basis for making decisions. Therefore, during the calendar year when the CFLIs are formulating their prioritizations, when the Air Force acquisition community is contemplating acquisition strategies and programmatic decisions, or when the AFCS is "getting to the bottom line," there will be greater participation, a higher degree of transparency, and better alignment for the service's decision making.

The proposed approach will give Air Force leaders, from the secretary / chief of staff through the MAJCOMs, better decisional knowledge by integrating the best information from each of the service's de-



cision support systems and organizing it in a way that leads to maximizing value and war-fighting capability over the short term and long term. This approach makes assumptions and constraints transparent while offering both a method to simultaneously evaluate the costs and benefit of decisions and the means to examine broader sets of alternatives over multiple scenarios. We consider these elements the basis for developing sound business cases for Air Force decisions—elements that will provide the secretary / chief of staff a better tool kit for communicating and defending decisions to the Office of the Secretary of Defense and Congress.

Limitations of a Value-Driven Approach

Implementing a value-driven approach involves a number of problems. Defining and agreeing on a common definition of value can prove difficult for leaders since some stakeholders have no incentive to participate or may seek ways to manipulate the process. Further, in organizations where one individual does not have dictatorial power, there is currently no unique solution for putting all the stakeholders' utility together. This situation highlights the need to negotiate and find mutually beneficial solutions (i.e., those that fall on mutual Pareto surfaces). The estimations of costs often entail high uncertainty that can make trade spaces difficult to interpret and cause decision makers to reach wrong conclusions. Additionally, the underlying assumptions and planning scenarios necessary to develop trade spaces could often be wrong or inaccurate. Leaders must endeavor to evaluate and, oftentimes, challenge these assumptions to mitigate the danger of arriving at bad conclusions. They must understand these limitations if we wish to adopt this method.

Conclusion

Despite these impediments, we believe that the proposed approach offers a practical pathway to tame the tigers in our three-ring Big "A"



circus. This begins with development of a long-term vision for the Air Force and a clear articulation of value. This definition of the latter will serve as the lens for evaluating the service's decisions and thus will drive alignment within and between the processes of our three rings of planning, budgeting, and acquisition. We believe that now is a perfect time to start implementing a new approach. The Air Force Quadrennial Defense Review office could adopt a value-focused approach in preparation for the next review. If successful, that approach could then become fully integrated into the Air Force's decision cycle, starting with an upcoming CORONA, thereby affecting and shaping our requirements, budget, and acquisition processes. This would include more continuous involvement from the secretary/chief in conjunction with the other four-stars to lay out a vision and foundation of assumptions for the future force. By implementing a value-driven approach, the Air Force will have a better engine for justifying and communicating its decisions. In our experience, value-driven decisions guided by clear strategic vision and supported by rigorous operational and business-case analysis can fulfill national-policy goals in a responsible, efficient, and defensible manner. ★

Notes

1. Michael Meese, "Defense Decision Making under Budget Stringency: Explaining Downsizing in the United States Army" (PhD diss., Woodrow Wilson School of Public and International Affairs, Princeton University, 2000). One of Colonel Meese's key findings is that decisions made in times of budget stringency have disproportionate effects on military services over time. See also Michael Donley, "On the Air Force's Budgetary Balancing Act," AOL Defense, 8 January 2013, <http://defense.aol.com/2013/01/08/sec-donley-on-the-air-forces-budgetary-balancing-act-exclusiv/>; and Secretary of the Air Force James G. Roche and Barry Watts, Op-Ed, "Confronting Threats of Military Modernization," *Politico*, 26 September 2012.
2. Air Force Instruction 16-501, *Control and Documentation of Air Force Programs*, 15 August 2006, http://static.e-publishing.af.mil/production/1/af_a3_5/publication/afi16-501/afi16-501.pdf.
3. Frank Kendall, undersecretary of defense, to defense acquisition workforce, memorandum, subject: Better Buying Power 2.0: Continuing the Pursuit for Greater Efficiency and



Productivity in Defense Spending, 13 November 2012, <http://www.defense.gov/news/BBPWorkforceMemo.pdf>.

4. Donna Miles, "Acquisitions Chief Outlines Streamlined Processes," *Army.com*, 15 March 2007, <http://www.armyreal.com/news/item/2810>.

5. "Business Model," ExxonMobil, accessed 30 January 2013, <http://ir.exxonmobil.com/phoenix.zhtml?c=115024&p=irol-model>.

6. Lisa Daniel, "Comptroller: Panetta Directive Pushes Audit Readiness," *American Forces Press Service*, 19 April 2012.

7. Miles, "Acquisitions Chief."

8. Over the past 10 years, several leading universities have created academic programs tailored to address interdisciplinary challenges in the technology, management, and policy domain. Notable programs include MIT's Engineering Systems Division, Stanford's Engineering and Management Science Department, Carnegie-Mellon's Engineering and Public Policy Program, Stevens Institute of Technology's School of Systems and Enterprises, and Johns Hopkins's Systems Institute.

9. Adam M. Ross et al., "Multi-attribute Tradespace Exploration as Front End for Effective Space System Design," *Journal of Spacecraft and Rockets* 41, no. 1 (January–February 2004): 20–28, <http://web.mit.edu/adamross/www/AIAA-9204-452.pdf>.

10. Gen Duncan J. McNabb, "We Measure Success through the Eyes of the War Fighter," *Air and Space Power Journal* 25, no. 4 (Winter 2011): 8–18, http://www.airpower.maxwell.af.mil/airchronicles/apj/2011/2011-4/2011_4.pdf.

11. Ralph L. Keeney and Howard Raiffa, *Decisions with Multiple Objectives: Preferences and Value Tradeoffs* (Cambridge, UK: Cambridge University Press, 1993); and Thomas L. Saaty and Kirti Peniwati, *Group Decision Making: Drawing Out and Reconciling Differences* (Pittsburgh, PA: RWS Publications, 2008).

12. Richard de Neufville and Stefan Scholtes, *Flexibility in Engineering Design* (Cambridge, MA: MIT Press, 2011); Nassim Nicholas Taleb, *The Black Swan: The Impact of the Highly Improbable*, 2nd ed. (New York: Random House Trade Paperbacks, 2010); and Richard Danzig, *Driving in the Dark: Ten Propositions about Prediction and National Security* (Washington, DC: Center for New American Security, October 2011), http://www.cnas.org/files/documents/publications/CNAS_Prediction_Danzig.pdf.

13. Adam M. Ross, Donna H. Rhodes, and Daniel E. Hastings, "Defining Changeability: Reconciling Flexibility, Adaptability, Scalability, Modifiability, and Robustness for Maintaining System Lifecycle Value," *Systems Engineering* 11, no. 3 (Fall 2008): 246–62.



Maj Gen Robert Kane, USAF

Major General Kane (BS, Grove City College; MS, University of Southern California) is the director of Global Reach Programs, Office of the Assistant Secretary of the Air Force for Acquisition. He is responsible to the Air Force acquisition executive for airlift, air refueling, training, and special operations programs. The general has served in Turkey, Korea, Germany, and Iraq in a wide variety of operational and staff assignments, including commands at the squadron, group, wing, and center levels. As commander of the Kaiserslautern Military Community and 86th Airlift Wing, he was instrumental in leading the Ramstein community to win the 2006 Commander in Chief Annual Award for Installation Excellence. Prior to this assignment, he served as commander of the Spaatz Center for Officer Education and commandant of the Air War College, Maxwell AFB, Alabama. During a 2009 deployment, he was commanding general of the Coalition Air Force Training Team, Baghdad, Iraq, responsible for coalition efforts to rebuild the Iraqi air force. General Kane is a command pilot with more than 4,200 hours in a number of military and commercial derivative aircraft.



Lt Col Jason Bartolomei, PhD, USAF

Lieutenant Colonel Bartolomei (BS, Marquette University; MS, Air Force Institute of Technology; PhD, Massachusetts Institute of Technology) is the deputy of the Program, Budget, and Congressional Division in the Directorate of Global Reach Programs, Assistant Secretary of the Air Force (Acquisition). He supports a \$52 billion weapon-system acquisitions portfolio that includes the Air Force's tankers, airlift, special operations, and trainer fleets. He served as a program element monitor for the KC-46A tanker, an F-22 systems engineer, and an assistant professor of engineering at the US Air Force Academy. A fully qualified joint officer, Lieutenant Colonel Bartolomei led the Joint Warfare Analysis Center's counterterrorism support team during 2007–10. He was a Service Chiefs' Fellow at the Defense Advanced Research Projects Agency in 2010 and a Military Legislative Fellow for Senator Orrin G. Hatch (R-UT) in 2011.

Let us know what you think! Leave a comment!

Distribution A: Approved for public release; distribution unlimited.

Disclaimer

The views and opinions expressed or implied in the *Journal* are those of the authors and should not be construed as carrying the official sanction of the Department of Defense, Air Force, Air Education and Training Command, Air University, or other agencies or departments of the US government.

This article may be reproduced in whole or in part without permission. If it is reproduced, the *Air and Space Power Journal* requests a courtesy line.

<http://www.airpower.au.af.mil>

The Air War in Libya

Maj Jason R. Greenleaf, USAF

If there is one attitude more dangerous than to assume that a future war will be just like the last one, it is to imagine that it will be so utterly different we can afford to ignore all the lessons of the last one.

—Sir John C. Slessor, *Air Power and Armies*, 1936

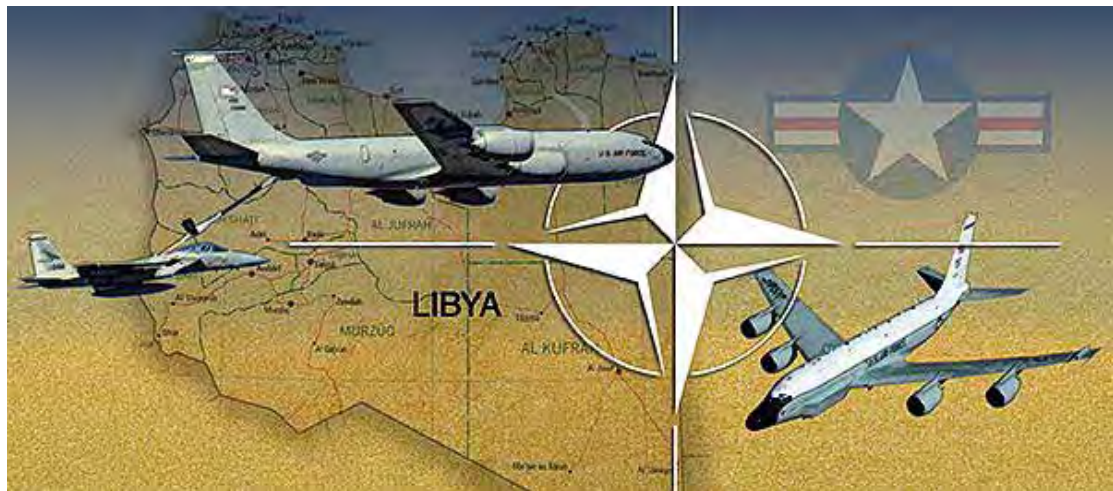

More than a year has passed since the last air mission of the North Atlantic Treaty Organization's (NATO) Operation Unified Protector concluded.¹ In just over seven months, the Western-led air campaign (see figure below), initiated in response to a United Nations Security Council resolution (UNSCR) to protect Libyan civilians, allowed a ragtag group of rebels to bring about the defeat of a well-armed military and the downfall of a dictatorship that spanned more than 40 years. Since the end of the mission, little public discussion or analysis of the campaign has taken place. Although some skepticism remains regarding the future of the oil-rich North African nation, an overwhelming consensus of opinion considers the air war in

Libya a resounding success and a testament to what a coalition-led operation can do. Tomas Valasek, of the Center for European Reform in London, asserts that it was “as good a war as it comes.”² Diplomats from the United States and Europe agree with this evaluation, similarly describing the war’s merits in superlatives. Before we consider replicating the coalition’s efforts in another intervention, however, more deliberate review and scrutiny are not only prudent but required. Additionally, a thorough analysis reveals that these assessments do not address many operational issues that proved problematic and need further examination, including linkages to overall airpower implications and key concerns. In the end, although the campaign may have attained its strategic objectives, operationally it should in many ways serve as a wake-up call for everyone involved.

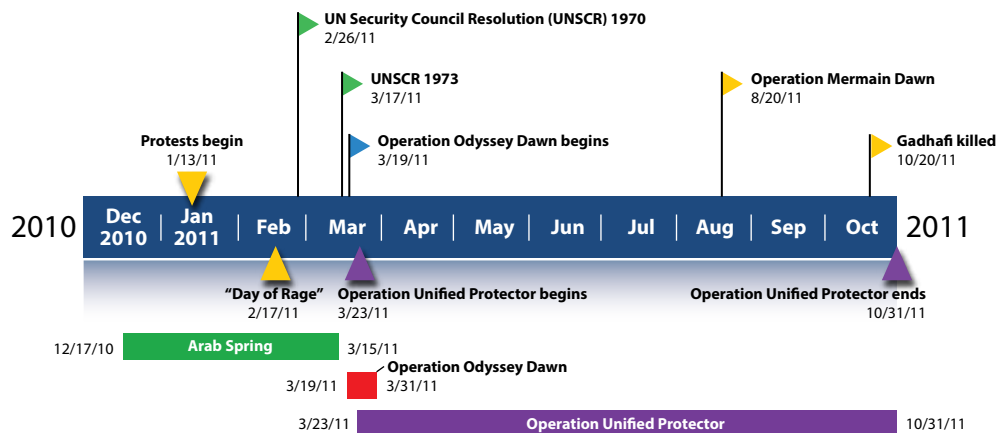

Figure. Timeline of the Libyan air campaign. Unified Protector consisted of three elements. NATO commenced an arms embargo on 23 March 2011 and enforcement of a no-fly zone on 25 March. On 31 March, NATO took control of all military operations, including the protection of civilians from attack or threat of attack. (“Operation Unified Protector: Final Mission Stats,” NATO.int, 2 November 2011, http://www.nato.int/nato_static/assets/pdf/pdf_2011_11/20111108_111107-factsheet_up_factsfigures_en.pdf.)

Operation Odyssey Dawn

So for those who doubted our capacity to carry out this operation, I want to be clear: The United States of America has done what we said we would do.

—President Barak Obama

From the outset, the United States did not want to take on the lead role during the crisis in Libya. Secretary of Defense Robert Gates advised against the establishment of a no-fly zone; even after Operation Odyssey Dawn began, he insisted that the conflict in Libya was not a vital interest to the United States.³ Despite this initial reservation, Joint Task Force Odyssey Dawn stood up on 3 March 2011, commencing air operations on 19 March. Almost immediately thereafter, the United States began working diligently to transfer control of the campaign to NATO.⁴ By 31 March, that organization had assumed full responsibility for the mission, with the United States taking on a secondary, supporting role in Unified Protector, and Odyssey Dawn concluded. Despite the brevity of the operation—less than two weeks of actual combat—it brought to light many deficiencies, both tactical and strategic. Nevertheless, this fact should not detract from the impressive feat of standing up a joint task force, focusing a coalition of 15 participant nations despite rapidly changing strategic guidance, executing 2,000 missions to gain air supremacy, and handing over operations to another organization—all in less than a month. As the joint force air component commander, Maj Gen Margaret Woodward, USAF, would later recall, “History is clear . . . the operation was a great success.”⁵ Failure to capture the improvements that need to take place, though, would be a disservice to those involved in this conflict and in future actions.

US Lessons Identified

US Africa Command (AFRICOM), tasked as the lead command for the operation, found itself beset with organizational deficiencies from the beginning. Secretary Gates unknowingly highlighted these inadequa-

cies during activation of the command in 2008, noting that “AFRICOM’s mission is not to wage war, but to prevent it.”⁶ Initially tasked with a noncombatant evacuation operation and then reoriented toward a kinetic operation, the newest geographic combatant command had difficulty executing a mission it was never intended to carry out.⁷ The lean staff (300 personnel) had never practiced joint task force operations with its component commands; neither could its air operations center (AOC) serve as anything other than “a transportation command to support personnel and material transfers within the (theater).”⁸ Instead, AFRICOM had to rely heavily on European Command’s personnel, facilities, and expertise to execute the mission successfully. Organized, trained, and equipped only to conduct theater engagement, AFRICOM struggled to put together a last-minute air campaign.⁹ The rapidly developing strategic direction and shortfall in resources complicated the command’s ability to carry out the mission, but external constraints also impeded progress.¹⁰

General Woodward quickly recognized the shortfalls and limitations that she faced with the organic capability at her disposal. As the mission evolved from a noncombatant evacuation operation, to a no-fly zone, to a mandate to protect civilians, the scope and sense of urgency grew as well. Unable to keep up with this sense of urgency, however, were the global force management / request for forces processes that the services use to apportion, assign, and allocate forces and “obtain required support not already assigned or allocated to the command.”¹¹ Even though the first and only request for forces was submitted early and “almost immediately validated by AFRICOM and the Joint Staff, the approval for these resources simply did not occur in time for operations.”¹² This want of resources proved the most challenging constraint in the development of strategy for the air campaign.¹³ Particularly detrimental was the absence of critical aircraft such as the E-3 Airborne Warning and Control System (AWACS), the E-8 Joint Surveillance Target Attack Radar System (JSTARS), and additional tankers that arguably should have been there first but did not arrive until after combat operations began.¹⁴ Additionally, because intelligence, surveil-

lance, and reconnaissance (ISR) assets possessing full-motion video were not available until after NATO took over the mission, pilots found it difficult to distinguish the rebels from the forces loyal to Mu'ammar Gadhafi and to identify time-sensitive targets. Indeed, after the pro-Gadhafi forces abandoned their conventional equipment, differentiating between the two forces without persistent ISR assets that could develop pattern-of-life information proved nearly impossible. Coupled with UNSCR 1973, which restricted the employment of NATO ground forces, the lack of ISR inhibited accurate battle damage assessment and led to additional strikes on "targets that might have already been neutralized."¹⁵ The uncertainty about availability of assets and their arrival in-theater also affected the planners' efficient use of aircraft.

The decision regarding the basing of all airplanes coming into the theater appeared haphazard and did not effectively use the limited number of air-refueling assets available.¹⁶ The vastness of Libya, roughly the size of Alaska, and the lack of suitable airfields close to the no-fly zone increased the transit time and made nearly all assets reliant on air-to-air refueling. Basing decisions resulted in placing fighter assets closer to the conflict at the expense of the heavy aircraft. Consequently, to remain on station, the latter needed a tanker for each sortie. A classic *Catch-22* dilemma followed as the planners had to choose between fueling the heavy command and control (C2)/ISR platforms or the strike assets. The relatively few ISR assets, preplanned targets, and moral necessity of minimizing collateral damage meant that most attacks had to use dynamic targeting as well as strike coordination and reconnaissance tactics to seek out and destroy pro-Gadhafi forces.¹⁷ By their very nature, these two missions make strike assets dependent upon air battle managers aboard the heavy C2 platforms.¹⁸ Planners often had enough gas for aircraft that could pair shooters with targets or for the shooters themselves—but seldom both. Once a deliberate planning effort began, liaison officers and planners made changes that maximized the effectiveness of constrained resources. Clearly, this operation underscored the importance of aerial refueling and gaining access to bases. The tyranny of distance and the associated complexity of bas-

ing decisions in this theater were not new phenomena, however. Planners should have identified and mitigated these issues much earlier.¹⁹

One can say the same of communications barriers among allied forces. Gen Carter Ham, USA, commander of AFRICOM, praises the level of interoperability and coordination during *Odyssey Dawn* as the “ideal” that future operations should seek to attain.²⁰ Throughout that operation and into *Unified Protector*, though, several concerns impeded operations. Principal among these was the use of classified systems to communicate with NATO, a problem that hindered information sharing. US forces utilized the SIPRNET (Secret Internet Protocol Router Network) to plan and execute *Odyssey Dawn*, but NATO has no access to this system, instead using its Secret and Crisis Response Operations in NATO Operating Systems (CRONOS) for transmitting classified information.²¹ Although the battlefield information collection and exploitation system (BICES) emerged in the late 1980s to bridge this gap, it was not widely available for US forces and “didn’t exist in AFRICOM.”²² The absence of BICES complicated the handover to NATO, especially during the early stages of *Unified Protector*. Until the system became available at staging locations for US assets, no secure means existed for transmitting the air tasking order and other mission information. Thus, liaison officers could pass basic sortie information only to the crews, which would then have to check in with the airborne C2 agency for the remainder of their air tasking order. Moreover, compatibility issues did not confine themselves to personnel on the ground.

Another problem arose in learning the detailed capabilities of coalition aircraft. Most assets belonged to NATO nations, but no mechanism existed for disseminating basic information from all participants regarding their aircraft capabilities. Planners’ lack of familiarity with the secure radio, data link, and other aircraft equipment of each nation had a detrimental effect on development of a communications plan, prioritization and deconfliction of frequencies, and the planning of search and rescue contingencies. The United States not only suffered from a paucity of compatible systems with its partners but also had

trouble getting the systems to communicate since the “NATO standard” proved neither standard nor even accessible to US assets. This issue applied to the loading of cryptology into radios and other devices to make them secure as well as to methodologies of employment such as the role played by tactical C2 assets like the AWACS.²³

Implications for US Forces

Fortunately, most of the seams identified in the US operation lend themselves to quick resolution. The United States should address deficiencies in the organizational structures of geographic combatant commands. According to General Ham, “Combatant commands don’t get to choose their missions.”²⁴ If they are to have the same responsibilities and authorities as other commands, then appropriate resources and mission sets need alignment. Odyssey Dawn exemplifies how certain commands are not task organized to execute the full array of combat missions yet may be expected to lead during unexpected contingency operations within their geographic boundaries. In the case of this operation, deciding who led the mission based upon lines on a map rather than capabilities caused much confusion and consternation. Without assigned operational forces, save those in Seventeenth Air Force and Joint Task Force–Horn of Africa, transferring the mission after it evolved into a large-scale kinetic operation would have proved more efficient. European Command, which ended up providing the bulk of the infrastructure, manning, equipment, and expertise, would have been a logical choice. The Department of Defense should carefully consider whether all geographic combatant commands will have capabilities to conduct both low- and high-end operations or whether it should continue with certain “limited mission” commands. The deactivation of Seventeenth Air Force on 25 April 2012 may reflect the inclinations of strategic decision makers.

In addition, the global force management / request for forces process demands further examination and refinement. The movement toward lean supply chains and a “just-in-time” mentality restricts the

flexibility of operations. Despite successfully executing a time-critical operation within a resource-constrained environment, the US Air Force could fully allocate assets for only four of the 90 requirements, a situation likely exacerbated by political realities because Congress did not approve this operation.²⁵ Although the deployment of assets does not depend upon such approval, its absence reveals the difficulty of rapidly responding anywhere in the world.²⁶ This also highlights a real danger of heavy reliance on what the Air Force calls “reachback,” which “refers to relying on Stateside combat and support aircraft . . . or to CONUS [continental United States]-based support personnel tied electronically to forward units.”²⁷ General Woodward echoed this sentiment, warning that *Odyssey Dawn* should serve as “a wake-up call.”²⁸ Much credit goes to the capabilities and professionalism of the service personnel who performed the mission with the few forces on hand, but we may discover during the next contingency that operating this way may not be enough or may come too late. The United States can do much to ensure that its infrastructure and systems enable the right assets to get to the right place on time by lessening the dependence on reachback and refining the global force management / request for forces process.

Furthermore, America must consider standardizing equipment and integrating it with that of NATO’s European members. It is incredible that members of the world’s largest military alliance would continue to develop and field incompatible systems. Even though the United States upgrades its C2/ISR platforms with secure air-to-ground Internet chat ability, the US version (known as mIRC) is not compatible with the NATO version (JChat).²⁹ Differing objectives, practices, and political constraints may drive nations to different procurement sources, but they should at least agree on standards that make systems interoperable. A service may elect to retain specific US-only systems as well, but it must have some means of operating with NATO partners. The absence of NATO standard items prescribed by standardized agreements undermines the already tenuous ability of the partnership to fight even fairly close to Europe. For the most part, the United States

has overcome problems associated with communications and cooperation among its services but must expand that standardization to NATO partners. In 2010 European Command recognized the need to employ BICES rapidly throughout the theater since “other NATO countries have been using the system for years”; nevertheless, the AOC possessed only one BICES terminal.³⁰ Even when personnel used compatible equipment, the limited access to standard, available cryptology meant that, in many cases, they had to use code words to pass sensitive information over clear radio frequencies. Transmitting a 10-line targeting message securely between forces that speak the same language is relatively time-consuming. Doing so between individuals possibly not fluent in English or laden with heavy, dissimilar accents brings the process to a grinding halt.

Finally, the inherent trust and familiarity among partners involved at the operational and tactical levels seemed missing or at least slow to develop. Many countries were reluctant to fully integrate from the beginning and limited their interaction with support elements from other nations. For example, largely due to its policy of neutrality, Sweden had not engaged in combat or even deployed operationally in over 50 years prior to Unified Protector.³¹ Certainly, no one questions the combat capability of Swedish forces, but they obviously had difficulty integrating seamlessly into NATO combat operations. To eliminate this hesitancy and improve mutual confidence, we must make regional exercises and training more realistic and inclusive. Participating in NATO or non-US-led coalition exercises will identify areas for improvement and any strictures in a training environment. The United States, however, has repeatedly shown that merely identifying lessons will not solve the problem since it quickly dismisses or forgets many of them. In 2000 the Air Force directed a comprehensive report by RAND that identified “potential interoperability problems that may arise in NATO Alliance operations or in U.S. coalition operations with NATO allies over the next decade” and offered solutions to mitigate those problems.³² Yet, during the execution of *Odyssey Dawn*, many of these challenges clearly remained, demanding real-time workarounds. Both

General Ham and General Woodward rightfully affirm that this operation was a “testament to the day-to-day training, exercising, and interoperability we’ve built with various partners around the world,” but the execution—especially during the early phases—reveals much room for improvement.³³

Operation Unified Protector

The operation has made visible that the Europeans lack a number of essential military capabilities.

—NATO Secretary-General Anders Fogh Rasmussen

NATO Lessons Identified

Unified Protector was the first major NATO air operation since 1999’s Operation Allied Force in the Balkans and the first time that Europeans have taken the lead role, with the United States agreeing to assume a supporting function.³⁴ An operation that began with much skepticism and shortcomings ended up prevailing, prompting some to declare it a model for future interventions.³⁵ Others felt that the operation represented a “dark lesson for NATO,” exposing fissures in the alliance and gaps in capabilities.³⁶ Regardless of the outcome of these debates, NATO must contend with some clear issues, both strategic and tactical.

Unified Protector suffered from a lack of strategic cohesion insofar as fewer than half of the member nations contributed to the operation.³⁷ Discounting US and Canadian participation, only six European countries delivered any offensive capability. In light of Allied Force, which boasted forces from 14 of the 19 alliance members, little wonder that some people call into question NATO’s ability to act in unison and ask what that bodes for the identity of future security. Last summer Secretary Gates blasted NATO, asserting that it had deteriorated into a two-tiered membership structure “between those willing and able to pay the price and bear the burdens of commitments, and those who enjoy the benefits of NATO membership but don’t want to share the

risks and the costs.”³⁸ Some of the nations that abstained could have participated but simply chose not to join the conflict.

In addition to such lack of resolve, Unified Protector exposed significant limitations in the alliance’s military prowess. In general, many European leaders utilized NATO as a means of securing US involvement and obtaining “unique capabilities” not found elsewhere in the alliance.³⁹ The United States filled gaps in ISR platforms, air-refueling aircraft, and drones. Flying only 25 percent of the sorties, America still supplied half of the aircraft, flew 80 percent of the air-refueling and ISR missions, and augmented airborne C2 with 25 percent of the coverage and control.⁴⁰ The remaining ISR came primarily from the United Kingdom and France, which also accounted for half of the strike forces—again reflecting the lack of burden sharing among participants.⁴¹ NATO also depended upon the United States for nearly all of its suppression of enemy air defense missions as well as combat search and rescue.⁴² Quite simply, without significant support from the United States, the European partners would have found it very difficult to conduct this operation as successfully as they did.

Even the assets supplied by the European nations could not sustain long-term combat operations. Initially, NATO expected a short-term Libyan action, forecasting operations only until July. That organization deserves credit for successfully passing two three-month extensions, but even though it may have thought itself prepared for the long haul, NATO forces and supplies were not. By early June, reports surfaced that several nations were running out of weapons, so the United States had to replenish their depleted stockpiles.⁴³ Soon after, Norway, which had contributed 17 percent of the strike missions with just six aircraft, announced that it would withdraw its forces because of the excessive burden involved.⁴⁴ (This should not detract from Norway’s contribution. That nation, along with Denmark and Belgium, “flew a percentage of the missions far beyond the size of their air forces,” further magnifying the disparity in burden sharing among NATO’s European members.)⁴⁵ The 26,500 sorties launched over the campaign may ap-

pear significant until one considers that in the 78 days of Allied Force, the coalition flew more than 38,000 sorties, non-US members flying 15,000 of those.⁴⁶ Of even greater concern during Unified Protector, air operations were designed “for an effort of 300 sorties a day but . . . struggl[ed] to manage 150.”⁴⁷ That “a very small operation” strained the alliance is troubling.⁴⁸

In addition to the lack of certain air assets, leading the operation on the ground proved more difficult than anticipated. Some senior officials contend that forces made a “seamless transition” from the US-led Odyssey Dawn to the NATO-led Unified Protector, but others involved in the operation dispute this claim, asserting that “momentum was lost during the transition to NATO control.”⁴⁹ Indeed, contending with the deficient facilities of the combined air operations center (CAOC) alone would have made the transition anything but seamless. The CAOC at Poggio Renatico, Italy, had no infrastructure to support the handful of permanently assigned personnel there at CAOC 5, let alone the hundreds of liaison officers and other support personnel descending onto the base. Within a few days, its temporary facilities were overflowing. Right away, NATO appeared neither properly organized nor resourced to take control of the operation.

Command and control of the campaign had transitioned from a US Air Force AOC with a robust communications and computer infrastructure to one without equipment for an operation of this scope. The coalition’s few securable radios (only two rudimentary satellite communications radios with handsets were available to conduct operations) compounded the new CAOC’s equipment problems. Since US assets did not enjoy JChat capability, nearly all airborne communication—both time critical and administrative—had to go through only two available frequencies. Additional equipment interoperability issues emerged: secure telephones on the AOC floor could not communicate with US secure phones at their bases, and neither side could access the other’s capability. The ad hoc facility constructed for US liaison officers gave them access to SIPRNET, satellite communications, and se-

cure phones to talk to their US counterparts but still did not allow them to communicate with the CAOC a few hundred yards away. As the author observed, messengers had to travel from one location to the other when personnel on the CAOC floor could not contact an airborne asset via the means available, or vice versa.

Differences in execution from *Odyssey Dawn* to *Unified Protector* did not stem merely from inadequate facilities; they also reflected the respective training programs and C2 structure. During *Odyssey Dawn*, the United States overcame the dearth of personnel experience by means of standardized training processes familiar to each person assigned to an AOC.⁵⁰ For the most part, each US AOC has the same functions, processes, and even a guidance document covering tactics, techniques, and procedures.⁵¹ Although the United States invests considerable time and effort training its AOC personnel, NATO does not. Because of its organizational structure and internal processes, NATO has no standing forces under its command, and force generation does not begin until the North Atlantic Council approves the concept of operations.⁵² The next step—the acquisition of assets and personnel—requires time for coordination across the entire NATO alliance, lending support to Lt Cdr Dave Ehredt's observation that "NATO is not known for its speed or agility when responding to an international crisis."⁵³ Because of the compressed transition schedule and NATO's slow, deliberate system, the CAOC in Italy needed major augmentation of US personnel—specifically targeting specialists.⁵⁴ Again, the author observed that NATO personnel working the CAOC functions on the floor had no experience, training, or qualifications to do so.

Problems with equipment and trained personnel at the CAOC magnified issues associated with the national caveats in a coalition structure. Any coalition has different rules of engagement (ROE), approval processes, and levels of collateral damage that any nation is willing to accept. *Unified Protector* involved no standing coalition rules, so the ultimate decision on whether or not to strike a target typically occurred not in the cockpit but back in the CAOC by the nations' "red

card holders”—senior officials consulted during the targeting process. This additional layer of decision making further compounded the time delays resulting from incompatible cryptology, language barriers, and reliance on dynamic targeting and strike coordination and reconnaissance tactics. Often low fuel forced a strike asset to return to base after it had waited more than 30 minutes for approval to engage a hostile target, sometimes leaving it intact. Early on in Unified Protector, these delays likely contributed to rebel complaints that NATO's air campaign was not doing enough to attrite regime forces.⁵⁵

Implications for NATO

Many of the issues that plagued the European-led NATO operation will not have an easy solution. The difficulty that the organization experienced in its attempt to gain consensus for an operation legally validated by UNSCR 1973 and deemed politically legitimate through support of the Arab League raises questions about NATO's European members ever coalescing around a common defense identity.⁵⁶ Some pundits perceive the operation as a “symbol of America's success in convincing its Allies that Europeans have to take a greater share of the burden and assume greater responsibility for security in Europe and its periphery.”⁵⁷ Indeed, although it was promising to witness the United Kingdom and France take the diplomatic lead in the operation, the transition to NATO served only to highlight the lack of capabilities that the United States seeks to leverage in the future.

Both the European NATO partners and the United States must address the capability gap that exists in Europe and the latter's reliance on America. Some analysts may extol the European countries' improved capabilities by citing the relative proportion of sorties flown or weapons expended by non-US NATO and coalition partners, but even “the most advanced fighter aircraft are of little use if the allies do not have the means to identify, process, and strike targets as part of an integrated air campaign.”⁵⁸ These are not optional extras in an air campaign; they are essentials that, at present, only the United States

seems able to provide.⁵⁹ Even with the European members' current capabilities, they must invest more in weapons and support to ensure successful operations in future conflicts. Allied Force taught us that shortages of precision-guided munitions pose a threat to the overall success of the mission.⁶⁰ In the much smaller Libyan operation, the problem arose again and early on. When NATO assumed control, the Libyan integrated air defense and airborne threat had already been eliminated, so NATO aircraft enjoyed a permissive environment from the start. Still, Gadhafi's antiquated defense system and minimal air force would likely have presented a daunting challenge to the Europeans alone. NATO relied on the United States not only for air assets but also for targeting and personnel, without which the operation would have proved far more problematic. Secretary of Defense Leon Panetta echoed his predecessor's warning to European leaders that the United States can no longer absorb and cover the alliance's shortcomings.⁶¹

Facing serious economic crises, the United States and European NATO partners are changing from the past practice of opulent spending and are attempting to minimize their investments on defense. Some nations, aware that they cannot afford a full spectrum of capabilities, appear to be molding their forces under the assumption that others can make up the difference. In the end, alliance participants may hedge their respective security objectives on leveraging the others' capabilities—which may or may not materialize in the future. Given the US national security strategy's dependence on alliance support, the United Kingdom's and others' diminishing force size, NATO's apparent two-tiered membership, and a global economic downturn, the prospect of burden sharing for collective security looks more daunting than anyone might have anticipated.

In the interim, NATO should seek innovative solutions as well as refine current structures and processes to find low-cost, high-payoff solutions. It may do so by improving training and rewriting publications so they align with actual practices of the member states. Several NATO members are in dire straits, and others face fiscal shortfalls, including

the US debt crisis. The alliance cannot afford to invest in disparate technologies or conflicting doctrine among member nations that require mutual support. NATO must also seriously consider merging and reorienting the C2 architecture further away from its legacy Cold War design.⁶² Instead of maintaining several smaller CAOCs with limited ability, the alliance would do better to concentrate on one or two facilities appropriately staffed, trained, and equipped for modern combat operations. NATO has taken steps to reduce some of its redundancies and architecture, but the current design still presents a mismatch of capabilities and ambitions as long as the strategic concept maintains “out of area” operations.⁶³

NATO would also benefit greatly from a training program similar to that of the United States—one which standardizes training for personnel assigned to a CAOC. Finally, although all nations that participate in future operations probably will not agree entirely on ROEs or on the amount of acceptable collateral damage, they could develop and codify a standard ahead of time to prevent the delays experienced in Libya. This might take the form of matrices of choices that a country’s representative accepts from the outset—for example, NATO Standard ROE 1a, CDE B, which informs planners and operators who they can task to which targets.⁶⁴ These changes will help reduce the friction involved in early stages of the operation and make the force more effective from the start. In the future, the alliance may not have the luxury of dealing with an adversary that permits a gradual, escalatory response.

Airpower Lessons and Implications

For good or for ill, air mastery is today the supreme expression of military power, and fleets and armies, however vital and important, must accept a subordinate rank.

—Winston Churchill, 1949

From the beginning of the Libya operation, scholars and pundits everywhere began postulating and prophesying what this operation would mean for airpower. Given that coalition ground forces would not participate, Odyssey Dawn offered a chance to finally determine whether airpower alone could attain victory. In the end, however, the operation produced no clear-cut results but suggested many different conclusions.

Key points regarding the use of airpower in Libya are important in many ways. First, the environment and circumstances associated with the war are likely representative of conflicts in the near future. Libya offered intervention advocates a new approach to attaining desirable outcomes when a “responsibility to protect” mission is warranted.⁶⁵ Tomorrow’s conflicts will also probably involve piecemeal alliances. Nations will be less inclined to conduct unilateral operations, and the coalition that develops will encompass a wide variety of partners with disparate capabilities and national caveats. Second, in light of the recent end of the drawn-out land war in Iraq and the upcoming withdrawal from Afghanistan, alliances probably will not agree to large troop commitments in the near future.

Airpower offers a responsive, relatively inexpensive, scalable, and low-risk option for political leaders. For all the talk about the expense of cruise missiles and smart bombs, these elements of airpower remain a fraction of the cost of deploying an army. Finally, as nations everywhere confront inevitable decreases in military spending, they must make tough choices about the programs they wish to keep. Some observers postulate that Libya’s results bode well for air forces around

the world while others suggest that the operations showed that these forces may not be worth the investment.

Some critics conclude that airpower failed to fulfill the promise of producing decisive results without support from a strong ground component.⁶⁶ Many theorists determined early on that Gadhafi's regime would crumble fairly quickly under coalition attack, yet it endured for seven months.⁶⁷ The regime certainly appeared to be heading for quick defeat when the first wave of attacks knocked out the Libyan air defense, grounded the air force, and flew unopposed within the first few days. But then "the world's premier military alliance and the three most formidable militaries in the world" barely prevailed "over a third-rate despot."⁶⁸ If the Libyans, whose defense spending was one eight-hundredth of the opposition's, nearly forced a stalemate with the Western alliance, then this campaign may not exemplify airpower's promise.⁶⁹

To address accusations of airpower's not having been decisive, proponents claim that it did not attain overwhelming results against Libya because of military and political constraints that relegated airpower to tactical choices rather than strategic targets.⁷⁰ Instead of attacking communications nodes and command centers, aircraft had to carry out the laborious and inefficient task of "tank plinking," as in Kosovo during Allied Force.⁷¹ Many people lament that such assignments turn "an air force into an exceedingly expensive artillery branch."⁷²

Furthermore, the rapidly evolving political environment prevented the NATO air chiefs from receiving clearly defined objectives. According to Gen Charles Horner, USAF, retired, who led the coalition air campaign in Operation Desert Storm, "To succeed, military leaders need clearly defined goals that can be achieved by the use of force."⁷³ Many airpower advocates considered the UNSCR overly constrained in terms of what the air forces could accomplish. The nebulous mission of "protecting civilians" did not clarify how far the alliance should go offensively against pro-Gadhafi forces. Initially, it was apparent that the alliance needed to stop their advance toward the rebel stronghold

of Benghazi, but after that the mission became more ambiguous.⁷⁴ NATO then took on a more graduated and coercive approach that did not at first target Gadhafi's military capacity or attempt regime change.⁷⁵

This constrained approach drew criticism from those looking for a “shock and awe” display of airpower and a quick, decisive victory, but it likely assured mission success because the rebels could not have exploited this initial advantage.⁷⁶ By extending the war and leveling the playing field for rebel forces, airpower gave the National Transitional Council the time it needed to organize and coalesce rather than create a power void. Perhaps, then, though not glamorous, airpower in Libya did exactly what it was supposed to do. The US Air Force has long contended that the strength of airpower lies in its flexibility and scalability. Among other forms of military power, only airpower can simultaneously hold a wide range of targets at risk and “provide a spectrum of employment options with effects that range from tactical to strategic.”⁷⁷

Regardless of the eventual assessments of air operations in Libya, one question that emerged and remains to be answered concerns the definition of the term *airpower*. The Air Force's capstone doctrine document describes it as “the ability to project military power or influence through the control and exploitation of air, space, and cyberspace to achieve strategic, operational, or tactical objectives.”⁷⁸ Conspicuously absent from this definition is any mention of delivering kinetic effects, indicating that airpower entails more than firing missiles and dropping bombs. NATO appeared to have sufficient strike assets but proved deficient in ISR, tankers, and remotely piloted aircraft. Displaying the versatility and adaptability of airpower, NATO's strike assets met some of the ISR requirements by fulfilling nontraditional-ISR collection roles as the ROEs developed for each nation. However, many individuals continue to argue that the limited number of enablers within NATO's European nations reflects significant gaps in what constitutes airpower. The fact that submarines launched a barrage of cruise missiles to destroy key air defense nodes illustrates the point that airpower involves

more than conventional aircraft.⁷⁹ This appears to demonstrate that in Libya, “the actual use of airpower . . . highlights the fact that ‘airpower’ is not necessarily the same thing as a country’s air force.”⁸⁰

Many people may correctly assert that smaller nations will never be able to afford the full range of capabilities that make up “airpower,” a fact that demands more focused attention on niche capabilities which contribute to the larger NATO force. If European members of NATO prefer specialization and the pooling and sharing of equipment for a common defense, then they must attain high degrees of coordination. Assuring the acquisition of correct assets and the proper training and equipping of personnel ready to plug into the overall airpower framework represents an enormous undertaking that demands substantial political cooperation.

Although we can say that “airpower” decided the campaign against Libya, it is less clear what that actually means. Undoubtedly, services and programs facing budget cuts will seek to leverage this ambiguity in vying for additional resources. The United States and European NATO forces involved in *Odyssey Dawn* and *Unified Protector* can extract and carry forward clear lessons from the planning and execution of the campaign. For advocates on either side of the primacy-of-airpower debate, however, the overall implications remain uncertain. It would be difficult to downplay the asymmetric advantage that coalition airpower gave the rebels; at the same time, the stagnation of NATO’s air campaign legitimately calls into question its exclusive application. Clearly, the coalition and its use of airpower did not provide an optimal operational template for future conflicts but will still likely inform future tactics, training, and transformation decisions. Though military and political leaders continue to extol the campaign as an exemplary low-risk military solution, the Libyan operation did not conclusively resolve the notion of airpower’s preeminence in war; in fact, it seems to have confused the traditional understanding of what airpower even means. Nor did the campaign clearly indicate how nations should shape their force during the inevitable period of budget austerity. One

hundred years after Italian captain Carlo Piazza first flew over Libya, it seems that Odyssey Dawn / Unified Protector may not have brought us any closer to answering some of these timeless airpower questions. Two facts, however, remain unquestionable: we must attain and maintain control of the air, and the legacy of the air campaigns in Libya will persist for some time.⁸¹

Conclusion

None would dare to aver that there will be no more war, for if that were so then the problem would have been forever solved; and if wars there are to be they will be lost or won in the air.

—Brig Gen P. R. C. Groves, Royal Air Force, 1922

After a brief campaign like Odyssey Dawn / Unified Protector, many reports will likely follow as more information becomes available. This critique in no way demeans or diminishes the action in Libya. In retrospect, perhaps we should embrace the assessment of Col Mark Desens, commander of the 26 Marine Expeditionary Unit: “Despite the warts . . . that you and I both know where those warts were . . . it was more or less successful . . . and certainly alleviated a lot of human suffering.”⁸² Undoubtedly, without the intervention, Gadhafi would have remained in power, and his forces would have brutally quelled the rebel uprisings in Benghazi and elsewhere throughout the country. Ultimately, history will judge the righteousness and success of the intervention.

Despite the successful outcome, if the United States and NATO's European members wish to continue partnering for similar interventions in the future, they must seriously examine this campaign's deficiencies and incorporate its lessons into future operations. America should examine the structure of its geographic combatant commands, refine its deployment processes, make compatible or standardize its technologies, and allow partner nations to take the lead in combined exercises. NATO has more difficult obstacles to overcome but, at the least, must start with a strategic decision by its members to determine their com-

mitment to conducting out-of-area operations. This determination will focus the development of capabilities during a period of economic downturn and allow allies to make informed decisions about maximizing interoperability with the organization. Even without clear-cut resolution to some of the timeless and recurring questions related to the efficacy of airpower, those on both sides of the debate must still carefully consider how the campaign will shape future engagements and force structure decisions. The next conflict will differ from this one, just as the Libyan operation differed from its predecessor. Rather than simply acknowledge the deficiencies of Odyssey Dawn / Unified Protector, however, the United States and NATO must heed Sir John Slessor's advice and learn from their experiences. ★

Notes

1. "Last Air Mission of Unified Protector Concluded," North Atlantic Treaty Organization, 31 October 2011, http://www.nato.int/cps/en/natolive/news_80133.htm.
2. Robert Marquand, "NATO Operation in Libya Ends after 7 Months, Could It Be a Model?," *Christian Science Monitor*, 31 October 2011, <http://www.csmonitor.com/World/Global-News/2011/1031/NATO-operation-in-Libya-ends-after-7-months-could-it-be-a-model>.
3. Jon Hilsenrath, "Gates Says Libya Not Vital National Interest," *Wall Street Journal*, 27 March 2011, <http://online.wsj.com/article/SB10001424052748704308904576226704261420430.html>.
4. Joint and Coalition Operational Analysis, *Libya: Operation Odyssey Dawn (OOD): A Case Study in Command and Control* (Suffolk, VA: JCOA, 4 October 2011), 2. (Hereafter Joint and Coalition Operational Analysis, *Operation Odyssey Dawn: A Case Study*.)
5. Maj Gen Margaret H. Woodward, "Defending America's Vital National Interests in Africa" (speech, the Air Force Association's 2011 Air and Space Conference and Technology Exposition, National Harbor, MD, 21 September 2011), <http://www.af.mil/information/speeches/speech.asp?id=671>.
6. Joint and Coalition Operational Analysis, *Operation Odyssey Dawn: A Case Study*, 9.
7. Joint and Coalition Operational Analysis, *Libya: Operation Odyssey Dawn (OOD): Executive Summary* (Suffolk, VA: JCOA, 21 September 2011), 4. (Hereafter Joint and Coalition Operational Analysis, *Operation Odyssey Dawn: Executive Summary*.)
8. *Ibid.*, 7.
9. *Ibid.*
10. Joint and Coalition Operational Analysis, *Operation Odyssey Dawn: A Case Study*, 8.
11. Joint and Coalition Operational Analysis, *Operation Odyssey Dawn: Executive Summary*, 5; and Air Force Instruction 10-401, *Air Force Operations Planning and Execution*, 7 De-

ember 2006, 19, http://static.e-publishing.af.mil/production/1/af_a3_5/publication/afi10-401/afi10-401.pdf.

12. Woodward, "Defending America's Vital National Interests."

13. Ibid.

14. John A. Tirpak, "Lessons from Libya," *Air Force Magazine* 94, no. 12 (December 2011): 36, <http://www.airforce-magazine.com/MagazineArchive/Documents/2011/December%202011/1211libya.pdf>.

15. Joint and Coalition Operational Analysis, *Operation Odyssey Dawn: Executive Summary*, 5.

16. Initially all tankers and heavy ISR assets were sent to Moron Air Base and Naval Air Station Rota, Spain. Not until later did some of the tankers begin to flow to Istres, France. JSTARS and AWACS aircraft eventually moved to Souda, Greece, following a more deliberate planning effort. The initial decision to send the AWACS/JSTARS and their large maintenance /support footprint to Rota meant that on a few occasions during Odyssey Dawn, they could not fly because of insufficient fuel. The subsequent move of all support elements for these aircraft also created delays in obtaining limited airlift to rebase them elsewhere. Additionally, Naval Air Station Sigonella, Italy, offers a suitable runway for tankers, but the maximum aircraft on the ground became an issue because of the decision to base all fighters there. To my knowledge, there was also no concerted effort, even after Unified Protector commenced, to utilize some of the NATO forward operating bases such as Aktion, Greece, and Trapani, Italy, for US assets.

17. Dynamic targeting prosecutes targets of opportunity that are either identified too late or not selected for action in time for inclusion in deliberate targeting but, when detected or located, meet criteria specific to realizing objectives. Joint Publication (JP) 3-60, *Joint Targeting*, 13 April 2007, viii, https://jdeis.js.mil/jdeis/new_pubs/jp3_60.pdf. Strike coordination and reconnaissance is a mission flown for the purpose of detecting targets and coordinating or performing attack or reconnaissance on those targets. Such missions, flown in a specific geographic area, are an element of the C2 interface to coordinate multiple air interdiction flights, detect and attack targets, neutralize enemy air defenses, and provide battle damage assessment. JP 3-03, *Joint Interdiction*, 14 October 2011, II-14, http://www.dtic.mil/doctrine/new_pubs/jp3_03.pdf.

18. In the author's experience, only one 24-hour AWACS orbit occurred during Odyssey Dawn / Unified Protector. The United States, United Kingdom, France, and NATO each flew one line/day. JSTARS flew every other day with the United Kingdom's Airborne Stand-Off Reconnaissance (ASTOR) aircraft alternating days but not providing 24-hour coverage.

19. Lt Col Michael W. Lamb Sr., *Operation Allied Force: Golden Nuggets for Future Campaigns*, Maxwell Paper no. 27 (Maxwell AFB, AL: Air University Press, August 2002), 1-2, <http://www.dtic.mil/cgi-bin/GetTRDoc?AD=ADA407618&Location=U2&doc=GetTRDoc.pdf>.

20. Tirpak, "Lessons from Libya," 38.

21. Joint and Coalition Operational Analysis, *Operation Odyssey Dawn: Executive Summary*, 19.

22. Joint and Coalition Operational Analysis, *Operation Odyssey Dawn: A Case Study*, 11. See also US Congress, Office of Technology Assessment, *New Technology for NATO: Implementing Follow-On Force Attack* (Washington, DC: Government Printing Office, June 1987), 118, <http://www.fas.org/ota/reports/8718.pdf>.

23. Personal observation and discussion with NATO E-3A liaison officers. Also highlighted in Myron Hura et al., *Interoperability: A Continuing Challenge in Coalition Air Operations* (Santa Monica, CA: RAND Corporation, 2000), 83, 85, 93, http://www.rand.org/content/dam/rand/pubs/monograph_reports/MR1235/MR1235.pref.pdf.

24. Tirpak, "Lessons from Libya," 35.

25. Briefing, Andrew Shelton, lessons-learned analyst, Third Air Force / A9, subject: Operation Odyssey Dawn: The USAFE Perspective, 25 October 2011.

26. Richard F. Grimmett, *War Powers Resolution: Presidential Compliance*, CRS Report for Congress RL33532 (Washington, DC: Congressional Research Service, 25 September 2012), i, <http://www.fas.org/sgp/crs/natsec/RL33532.pdf>.

27. Tirpak, "Lessons from Libya," 35.

28. Ibid.

29. Richard F. Bird and Don Kallgren, "Extending the Mission: NATO AEW beyond Line-of-Sight Airborne IP Communications," North Atlantic Treaty Organization, September 2010, <http://www.nc3a.nato.int/SiteCollectionDocuments/MP-IST-092-13.pdf>.

30. Rita Boland, "Building Bridges between Allies, Old and New," *SIGNAL Magazine*, September 2010, <http://www.afcea.org/content/?q=node/2382>.

31. Bill Sweetman, "Reluctant Warriors: Fighter Conference Reviews Lessons from Libya Campaign," *Defense Technology International* 5, no. 11 (December 2011): 19–20.

32. Hura et al., *Interoperability*, iii.

33. Amy McCullough, "Libya Mission," *Air Force Magazine* 94, no. 8 (August 2011): 30, <http://www.airforce-magazine.com/MagazineArchive/Documents/2011/August%202011/0811mission.pdf>.

34. Isabelle François, "NATO and the Arab Spring," *Transatlantic Current*, October 2011, <http://www.ndu.edu/inss/docUploaded/Transatlantic%20Current%201.pdf>.

35. Julian E. Barnes and Adam Entous, "NATO Air Strategy Gains Renewed Praise," *Wall Street Journal*, 21 October 2011, <http://online.wsj.com/article/SB10001424052970203752604576643531745513712.html>.

36. Steven Erlanger, "Libya's Dark Lesson for NATO," *New York Times*, 3 September 2011, <http://www.nytimes.com/2011/09/04/sunday-review/what-libyas-lessons-mean-for-nato.html?pagewanted=all>.

37. John Barry, "Lessons of Libya for Future Western Military Forays," European Institute, August 2011, <http://www.europeaninstitute.org/EA-August-2011/lessons-of-libya-for-future-western-military-forays.html>.

38. Thom Shanker, "Defense Secretary Warns NATO of 'Dim' Future," *New York Times*, 10 June 2011, <http://www.nytimes.com/2011/06/11/world/europe/11gates.html>.

39. Joint and Coalition Operational Analysis, *Operation Odyssey Dawn: Executive Summary*, 18.

40. It is difficult to find a definitive source and data due to variations in what sources count as sorties (i.e., sorties, airframes, and hours). Sources differ in range from 70 to 85 percent. See Barry, "Lessons of Libya."

41. Ben Barry, "Libya's Lessons," *International Institute for Strategic Studies, Survival: Global Politics and Strategy* 53, no. 5 (October–November 2011): 11.

42. Francis Tusa, "Libya Reveals NATO Readiness Highs and Lows," *Military.com*, 2 December 2011, <http://www.military.com/features/0,15240,239146,00.html>.

43. Karen DeYoung and Greg Jaffe, "NATO Runs Short on Some Munitions in Libya," *Washington Post*, 15 April 2011, http://articles.washingtonpost.com/2011-04-15/world/35231577_1_nato-officials-cluster-bombs-munitions-in-civilian-areas; and Shanker, "Defense Secretary Warns NATO."
44. Michael Clarke et al., *Accidental Heroes: Britain, France and the Libya Operation* (London: Royal United Services Institute, September 2011), 6, <http://www.rusi.org/downloads/assets/RUSIInterimLibyaReport.pdf>.
45. Ken Gude and John Podesta, "Libya's Lessons for NATO's Europeans," *Europe's World*, Spring 2012, http://www.europesworld.org/NewEnglish/Home_old/Article/tabid/191/ArticleType/ArticleView/ArticleID/21945/language/en-US/Default.aspx.
46. Lamb, *Operation Allied Force*, 1–2.
47. Barry, "Libya's Lessons," 11.
48. Andrew Tilghman, "U.S. Official: NATO Military Capability Ebbing," *AirForceTimes.com*, 2 December 2011, <http://www.airforcetimes.com/news/2011/12/military-nato-military-capability-ebbing-120211w/>.
49. Jim Garamone, "NATO Makes Smooth Transition in Libya Operations," American Forces Press Service, 6 April 2011, <http://www.af.mil/news/story.asp?id=123250401>; and Joint and Coalition Operational Analysis, *Operation Odyssey Dawn: Executive Summary*, 19.
50. McCullough, "Libya Mission," 32.
51. Air Force Tactics, Techniques, and Procedures 3-3.AOC, *Operational Employment—Air and Space Operations Center* (U), 1 November 2007.
52. Joint and Coalition Operational Analysis, *Operation Odyssey Dawn: Executive Summary*, 17.
53. Dave Ehredt, "Command and Control—Exploring Alternatives: The Realities of Two C2 Models for Air Power Proponents," *Journal of the JAPCC* [Joint Air Power Competence Centre], no. 14 (Autumn 2011): 40, http://www.japcc.de/fileadmin/user_upload/journal/Edition_14/20111014_-_Journal_Ed-14_web.pdf.
54. Joint and Coalition Operational Analysis, *Operation Odyssey Dawn: Executive Summary*, 18.
55. Paul Smyth, "Libya: Is NATO Doing Enough?," Royal United Services Institute, 15 April 2011, <http://www.rusi.org/go.php?structureID=commentary&ref=C4DA85C7E0FB14>.
56. Kori Schake, "Lessons of the Libya War," *Defining Ideas*, 13 October 2011, <http://www.hoover.org/publications/defining-ideas/article/96531>.
57. François, "NATO and the Arab Spring," 4.
58. McCullough, "Libya Mission," 30. See also Ivo H. Daalder and James G. Stavridis, "NATO's Success in Libya," *New York Times*, 30 October 2011, http://www.nytimes.com/2011/10/31/opinion/31iht-eddaalder31.html?_r=1&adxnnl=1&adxnnlx=1351857791-jUaeHRA3HDly3sD0E5iD+Q&.
59. Richard de Silva, "Lessons from Libya: Gaddafi's Tactics—and NATO's Response," *Defence IQ*, 25 October 2011, <http://www.defenceiq.com/air-forces-and-military-aircraft/articles/nato-air-power-lessons-from-libya/>. Lt Gen Friedrich Wilhelm Ploeger, deputy commander of NATO's Allied Air Command–Ramstein, mentioned in this interview that "[Unified Protector] brought to light the importance of the enablers."
60. Lamb, "Operation Allied Force," 38.
61. Dan De Luce and Laurent Thomet, "After Libya, US Cannot Bail Out NATO Shortfalls: Panetta," Google News, 5 October 2011, <http://www.google.com/hostednews/afp/article>

/ALEqM5h1gfsyvWlWoK3EC-XPtsW-StYCAQ?docId = CNG.7637463e3ae1f3d504fb4d19a47f89ae.151.

62. W. Bruce Weinrod and Charles L. Barry, *NATO Command Structure: Considerations for the Future* (Washington, DC: Center for Technology and National Security Policy, National Defense University, 2010), 8.

63. NATO Public Diplomacy Division, *Active Engagement, Modern Defence: Strategic Concept for the Defence and Security of the Members of the North Atlantic Treaty Organization* (Brussels: NATO Public Diplomacy Division, 19–20 November 2010), http://www.nato.int/nato_static/assets/pdf/pdf_publications/20120214_strategic-concept-2010-eng.pdf.

64. These are notional values used here to describe how they could be predefined and available for planners. *ROE*, which refers to the specific rules of engagement or caveats that a nation may have, assists in determining if someone could service a target. A collateral damage estimate (CDE) equates to the level of risk one is willing to take with the possibility of unintended or incidental damage to persons or objects that are not the intended target. This is informed by and affects the type of weapon that may be employed. Having this information readily available is key to quickly interdicting threats, particularly in a dynamic targeting / strike coordination and reconnaissance operational environment.

65. Barry, "Libya's Lessons," 11.

66. Lee T. Wight, "Airpower Dollars and Sense: Rethinking the Relative Costs of Combat," *Joint Force Quarterly* 66 (3rd Quarter 2012): 54–61, <http://www.ndu.edu/press/airpower-dollars.html>; Patrick Cockburn, "NATO in Libya Has Failed to Learn Costly Lessons of Afghanistan," *Independent*, 24 July 2011, <http://www.independent.co.uk/voices/commentators/patrick-cockburn-nato-in-libya-has-failed-to-learn-costly-lessons-of-afghanistan-2319539.html>; and Adam J. Hebert, "Libya: Victory through Airpower," *Air Force Magazine* 94, no. 12 (December 2011): 4, <http://www.airforce-magazine.com/MagazineArchive/Documents/2011/December%202011/1211edit.pdf>.

67. Charlie Savage and Mark Landler, "White House Defends Continuing U.S. Role in Libya Operation," *New York Times*, 15 June 2011, http://www.nytimes.com/2011/06/16/us/politics/16powers.html?pagewanted=all&_r=0; Moni Basu, "Can Air Power End Libya War?," CNN.com, 30 June 2011, <http://globalpublicsquare.blogs.cnn.com/2011/06/30/can-air-power-end-libya-war/>; George Friedman, "The Emerging Doctrine of the United States," *Stratfor*, 9 October 2012, <http://www.stratfor.com/weekly/emerging-doctrine-united-states>; and Carlos Munoz, "Abrial: NATO Closing ISR, Intel Sharing Gaps Exposed in Libya," *AOL Defense*, 22 November 2011, <http://defense.aol.com/2011/11/22/abrial-nato-closing-isr-intel-sharing-gaps-exposed-in-libya/>.

68. Schake, "Lessons of the Libya War."

69. *Ibid.*

70. Robert Farley, "Over the Horizon: Drawing the Right Lessons on Airpower from Libya," *World Politics Review*, 26 October 2011, <http://web.ebscohost.com/ehost/detail?sid=dc5a6b4f-43f0-44d7-b8cc-eba3929ef1f8%40sessionmgr111&vid=1&hid=107&bdata=JnNpdGU9ZWhvc3QtbGl2ZQ%3d%3d#db=aph&AN=79973373>.

71. Maj Jody L. Blanchfield, USAF, *Bombs Away: A Strategic Analysis of Airpower in Limited Conflict* (Fort Leavenworth, KS: School of Advanced Military Studies, US Army Command and General Staff College, 12 May 2000), 34, <http://www.dtic.mil/cgi-bin/GetTRDoc?AD=ADA381825>.

72. Farley, "Over the Horizon."

73. Charles A. Horner, "Air Power Could Be Enough in Libya," *Wall Street Journal*, 24 March 2011, <http://online.wsj.com/article/SB10001424052748704050204576218813676422854.html>.

74. "Early Military Lessons from Libya," *IISS* [International Institute for Strategic Studies] *Strategic Comments* 17, comment no. 34 (September 2011): 1–3, <http://www.iiss.org/publications/strategic-comments/past-issues/volume-17-2011/september/libya-early-military-lessons/>.

75. *Ibid.*

76. Dr. Christian F. Anrig, "Allied Air Power over Libya: A Preliminary Assessment," *Air and Space Power Journal* 25, no. 4 (Winter 2011): 104, http://www.airpower.au.af.mil/airchronicles/apj/2011/2011-4/2011_4.pdf.

77. Air Force Doctrine Document 1, *Air Force Basic Doctrine, Organization, and Command*, 14 October 2011, 16, <http://www.e-publishing.af.mil/shared/media/epubs/AFDD1.pdf>.

78. *Ibid.*, 129.

79. Farley, "Over the Horizon."

80. *Ibid.*

81. Trish Turner, "McCain Calls for Air Strikes against Syria's Assad," *Fox News*, 5 March 2012, <http://www.foxnews.com/politics/2012/03/05/mccain-calls-for-air-strikes-against-syrias-assad/>.

82. Col Mark Desens, commander of 26 Marine Expeditionary Unit during Operation Odyssey Dawn, interview by the author, 7 December 2011.



Maj Jason R. Greenleaf, USAF

Major Greenleaf (USAF; MBA, Trident University International; MMS, Marine Corps University) is currently a division operations officer in the Directorate for Collection Management, Defense Intelligence Agency. He assists with the direction and administration of the division's joint military and civilian personnel, managing the Department of Defense's standing, time-sensitive, and crisis collection requirements. A senior pilot with more than 2,750 hours in the C-21A and E-3B/C, he formerly served as a formal training unit evaluator pilot and chief of Operations Group Standardization and Evaluation at Tinker AFB, Oklahoma. Major Greenleaf is a graduate of Squadron Officer School and the Marine Corps Command and Staff College.

Let us know what you think! Leave a comment!

Distribution A: Approved for public release; distribution unlimited.

Disclaimer

The views and opinions expressed or implied in the *Journal* are those of the authors and should not be construed as carrying the official sanction of the Department of Defense, Air Force, Air Education and Training Command, Air University, or other agencies or departments of the US government.

This article may be reproduced in whole or in part without permission. If it is reproduced, the *Air and Space Power Journal* requests a courtesy line.

<http://www.airpower.au.af.mil>

A Case for Air Force Reorganization

Col Jeffrey P. Sundberg, USAF



In light of the US Air Force's largest baseline budget decrease since 1994 and the most acute Department of Defense (DOD) budget decline since 1991 (with more cuts likely), financial pressures have forced the service to reduce costs and improve efficiencies in certain areas.¹ This article examines matters not often addressed in Air Staff money drills and capabilities assessments—specifically, it looks at the Air Force's top-level organizational structure, primarily targeting the organization and personnel categories of the doctrine, organization, training, materiel, leadership and education, personnel, and facilities (DOTMLPF) framework.

The argument presented here would remove a layer of the organization to flatten the structure, eliminating the major commands (MAJ-COM) and increasing responsibilities of the Air Staff and numbered air forces (NAF). Given this new structure, the Air Staff would absorb a

large number of administrative functions currently held by the MAJCOMs. The NAFs would align regionally with combatant commands (COCOM), providing the crucial links to war-fighting commanders, and dedicate air staffs to handle regional conflicts and requirements. This proposed organization should improve support to COCOMs, advance Air Force regional expertise and focus through the NAFs, adapt more quickly to global situations, and ensure that the service's history and traditions endure. If these suggested recommendations improve organizational agility, increase combat capability, and reduce long-term costs, the Air Force could enhance operational effectiveness and save finite resources for other critical programs.

The National Security Act of 1947 created a separate Air Force with an initial organizational structure built from its Army roots. Over the next 65 years, the service morphed and expanded to its current structure (fig. 1). The primary mission of the Air Force and its responsibilities have changed little since 1947. Ultimately, the Air Staff prepares the service to fight the nation's wars; at such a time, forces are assigned to the appropriate COCOM to execute the mission. Today's Air Force consists of 10 MAJCOMs organized both geographically and functionally to carry out this title 10 mission.² In general the eight US-based MAJCOMs align functionally while the two overseas commands—US Air Forces in Europe and Pacific Air Forces—organize by geographic area. Except for Air Force Materiel Command (AFMC), every MAJCOM contains at least one NAF.

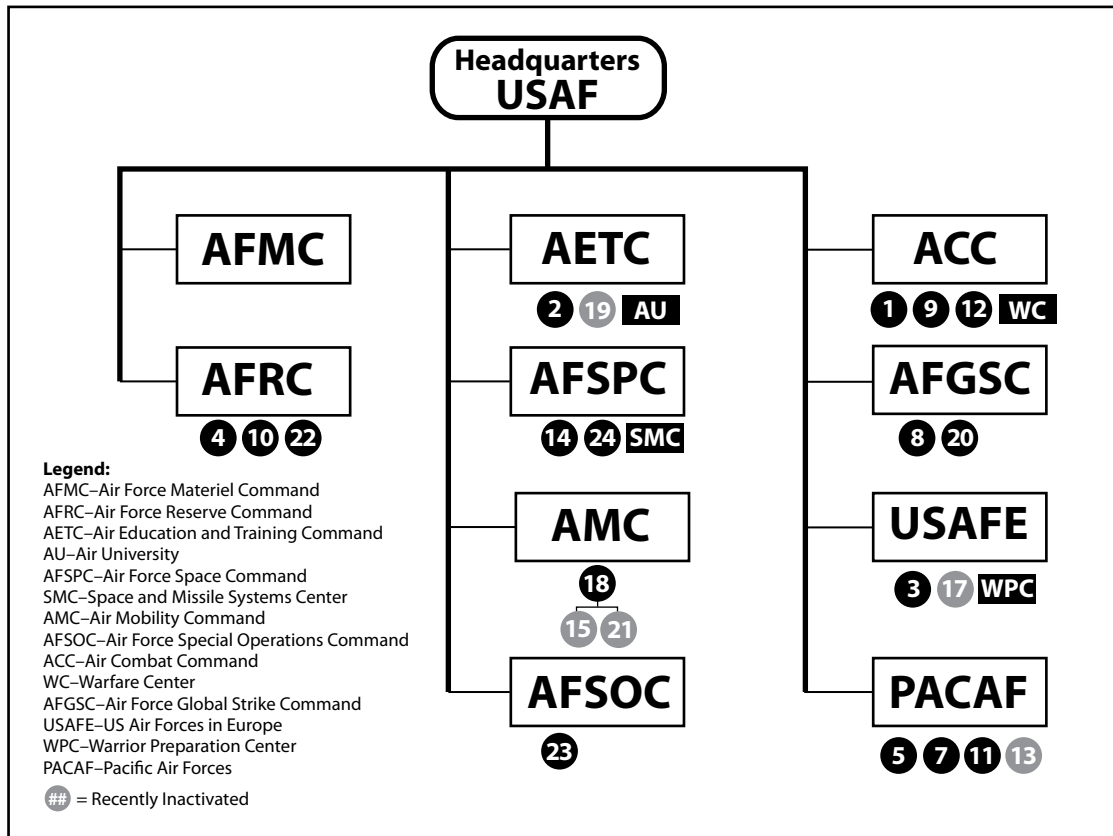

Figure 1. Organizational structure of the Air Force. (Data from “The Air Force in Facts and Figures: 2010 USAF Almanac,” *Air Force Magazine* 93, no. 5 [May 2010]: 36–66, http://www.airforce-magazine.com/MagazineArchive/Magazine%20Documents/2010/May%202010/0510facts_figs.pdf. Circles represent NAFs subordinate to MAJCOMs, and rectangles depict major centers, except for all of AFMC’s.)

A total of 15 NAFs currently fall subordinate to nine MAJCOMs. Mostly found in AFMC, 16 centers also manage crucial Air Force functions. Subordinate to the NAFs and centers, 131 active duty and 34 reserve wings generate the basic combat units for employment. As of 2011, the Air Force consisted of 329,000 active duty personnel and more than 183,000 supporting civilians. The service flies approximately 4,600 active duty systems to train, test, and fight.³ Given these

key organizational demographics, the following comprehensive analysis dissects the structure from several perspectives, identifies problems, discusses past reorganization efforts, outlines key tenets of the Air Force's structure, and proposes an organizational change as a solution for the future.

Analysis of the Air Force's Organizational Structure

As mentioned above, the Air Force's initial organizational structure derived from the Army's but has since changed. In terms of sheer size and structure, alterations and the bureaucracy itself have created problems. We must assess the consequences of more than 65 years of organizational development and growth in light of current fiscal realities. Dramatic changes have occurred in the size of the force and the force structure over time. Based on personnel and force-structure analysis in relation to the organization, indicators suggest an overgrowth of staff officers and civilian personnel disproportionate to the decreasing size of the force and force structure.

Organizational Size

Several factors have affected the Air Force's organizational size over the course of history. Technology and the acquisition of new weapons systems have been the principal drivers since the service's inception, and they continue in that role today. The nature of the threat, budgetary limitations, and wars also affect the growth or reduction of the Air Force.⁴ In all categories, the Air Force of 2013 is vastly smaller than its predecessors. This examination of the organization over time assesses two key statistics: size of force and force structure. *Size of force* refers to the number of active duty Airmen or civilians in the service. It does not consider the contracting force—significant but difficult to measure—although the Defense Business Board observes that “there has also been an explosive growth in the number of DoD contractors.”⁵ *Force structure* represents the machines that make up the Air Force's war-fighting capa-

bilities, including training and testing systems, aircraft, nuclear missiles, and spacecraft operated by active duty personnel.

From 1947 to today, the size of force increased dramatically during the Korean War and then steadily declined, with spikes during the Vietnam War and prior to Operation Desert Storm (fig. 2). When the Air Force began as a separate service, it contained fewer than 350,000 Airmen in nearly 70 groups, considered wing equivalents. Near its Korean War peak in 1955, the service employed nearly 960,000 Airmen and 312,000 civilians.⁶ In 2012 the active duty component employed only 329,000 Airmen and 183,000 civilian personnel.⁷ Significant manpower changes over more than 65 years have prompted adjustments by the staff organizations as well. We first consider whether these staffs have grown proportionately and appropriately to support the size of force.

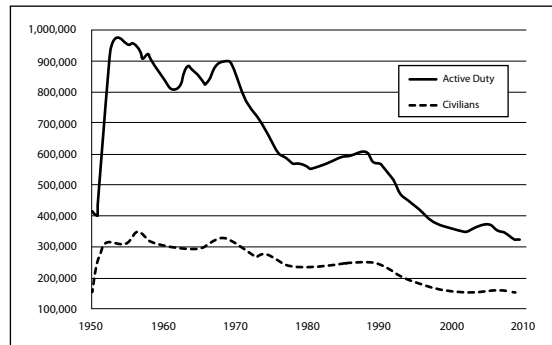

Figure 2. Air Force active duty / civilian personnel totals by year. (Data from “Air Force Strength from FY 1948–2012,” Air Force Personnel Center, accessed 9 January 2013, http://access.afpc.af.mil/vbinDMZ/broker.exe?_program=DEMOGPUB.static_reports.sas&_service=pZ1pub1&_debug=0; and “DoD Employment by Organization and Function” [see FY 2002–FY 2009] and “DoD Civilian Strength—Fiscal Years 1950–2001” [see table], accessed 31 January 2011, <http://siadapp.dmdc.osd.mil/personnel/CIVILIAN/CIVTOP.HTM>.)

The number of field grade (FG) officers and civilian personnel offers an indication of and insight into the staff size in comparison to overall personnel strength. Staff organizations above wing level contain the majority of FG officers, including colonels, lieutenant colonels, and majors. The same holds true for civilian personnel. For our purposes, the FG category will include only lieutenant colonels and majors; a separate category represents colonels. Drawing on statistics from 1950 to 2009, the analysis uses a simple ratio to compare the number of each category with the total size of force. The results (figs. 3, 4, and 5) show clear trends indicating that the three categories unequivocally increase over time.

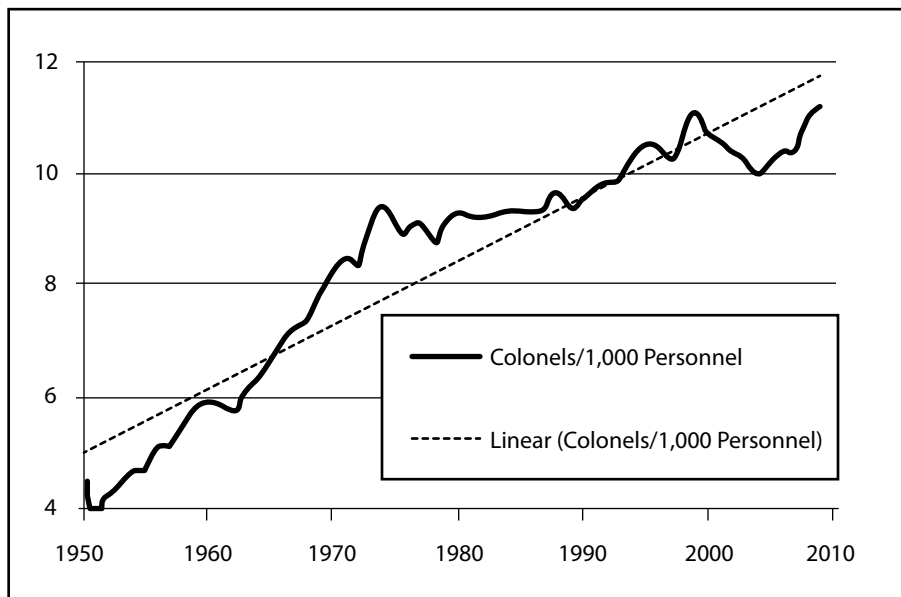

Figure 3. Colonels per 1,000 Air Force personnel. (Data from “Air Force Strength from FY 1948–2012,” Air Force Personnel Center, accessed 9 January 2013, http://access.afpc.af.mil/vbinDMZ/broker.exe?_program=DEMOGPUB.static_reports.sas&_service=pZ1pub1&_debug=0.)

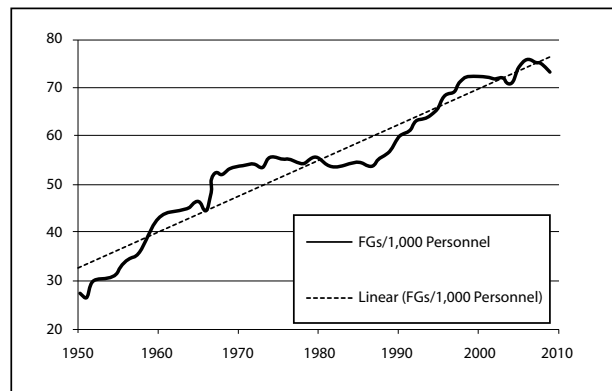

Figure 4. FGs per 1,000 Air Force personnel. (Data from “Air Force Strength from FY 1948–2012,” Air Force Personnel Center, accessed 9 January 2013, http://access.afpc.af.mil/vbinDMZ/broker.exe?_program=DEMOGPUB.static_reports.sas&_service=pZ1pub1&_debug=0.)

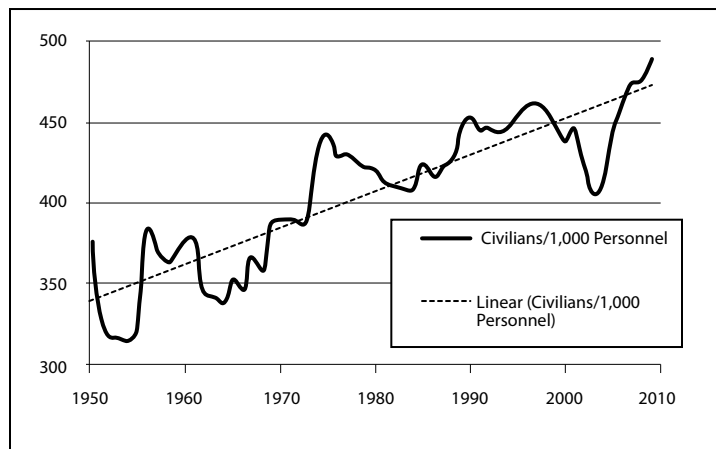

Figure 5. Air Force civilians per 1,000 personnel. (Data from “Air Force Strength from FY 1948–2012,” Air Force Personnel Center, accessed 9 January 2013, http://access.afpc.af.mil/vbinDMZ/broker.exe?_program=DEMOGPUB.static_reports.sas&_service=pZ1pub1&_debug=0; and “DoD Employment by Organization and Function” [see FY 2002–FY 2009] and “DoD Civilian Strength—Fiscal Years 1950–2001” [see table], accessed 31 January 2011, <http://siadapp.dmdc.osd.mil/personnel/CIVILIAN/CIVTOP.HTM>.)

In other words, for every 1,000 personnel in 1950, the Air Force employed 4.5 colonels, 28 FGs, and 376 civilians. By 1980 the officer numbers had essentially doubled to 9.3 colonels and 56 FGs, while the civilian number increased to 421. By 2009 the numbers had grown further still: 11 colonels, 74 FGs, and 488 civilians per 1,000 Airmen. General officers (not addressed here due to limited data) appear to follow identical trend lines over the same period. Since 1975 the number of Air Force general officers has declined by 17 percent, and both the size of force and force structure have decreased more rapidly (47 percent).⁸ These statistics indicate that the organization is growing appreciably more top heavy, suggesting that the requirement for staff positions has increased steadily. If that is not the case, then the Air Force's staff has grown disproportionately. One explanation would indicate that, as with any organization, the Air Force incurs an overhead cost for management and that these staff levels could represent the minimum necessary for operating. If, however, an overstaffing problem exists, several theories lend insight into why and how this overgrowth occurs. Noted German sociologist Max Weber discusses several reasons for overgrowth of staff positions and the challenge of organizational changes, articulating the fundamental truism that "once established and having fulfilled its task, an office tends to continue in existence and be held by another incumbent."⁹ Consequently, organizational offices will perpetuate, often well past usefulness, until forcible alteration or catastrophic failure.

Force structure levels provide another organizational insight to consider. Again, force structure includes all systems in the active duty Air Force's inventory. This approach analyzes how staff presence, as indicated by levels of higher-ranking officers and civilians, varies over time as a function of force structure. Again, the colonel, FG, and civilian categories encompass the measures analyzed. First, however, the total number of personnel per system offers some measure of assessment. Except for significant fluctuations during and after the Korean War, the total personnel-to-system ratio stabilizes at about 65 Airmen (fig. 6). Therefore, the Air Force has maintained a directly proportional

relationship between the number of systems and total strength of active duty personnel. One may attribute the minor increase to the fact that increasingly technological systems require more personnel for operations, information processing, and maintenance.

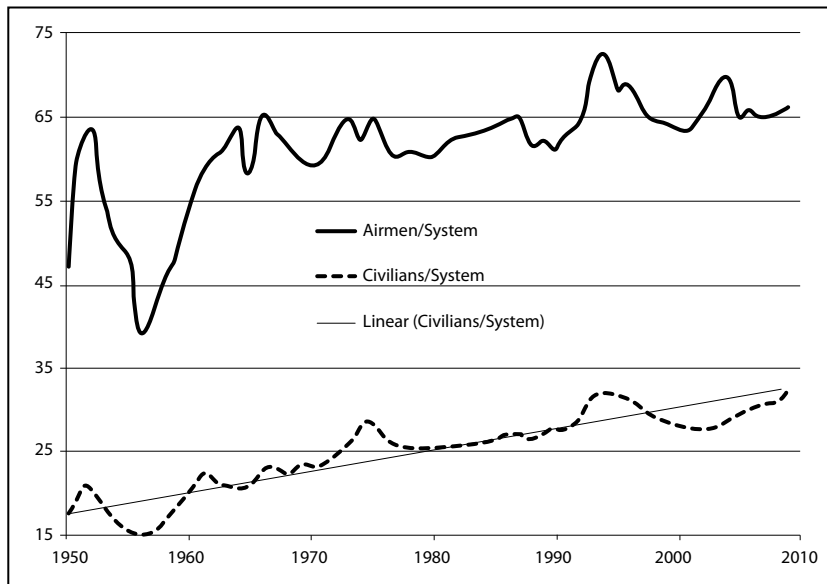

Figure 6. Total active duty Airmen and civilians per Air Force system. (Data from “Air Force Strength from FY 1948–2012,” Air Force Personnel Center, accessed 9 January 2013, http://access.afpc.af.mil/vbinDMZ/broker.exe?_program=DEMOGPUB.static_reports.sas&_service=pZ1pub1&_debug=0; “DoD Employment by Organization and Function” [see FY 2002–FY 2009] and “DoD Civilian Strength—Fiscal Years 1950–2001” [see table], accessed 31 January 2011, <http://siadapp.dmdc.osd.mil/personnel/CIVILIAN/CIVTOP.HTM>; and James C. Ruehrmund Jr. and Christopher J. Bowie, *Arsenal of Airpower: USAF Aircraft Inventory, 1950–2009* [Washington, DC: Mitchell Institute Press, 2010], 15–26, http://www.afa.org/mitchell/reports/MS_TAI_1110.pdf.)

All other categories show a different, increasing trend over time. In the 1960s, the civilian force stayed steady around 18 civilians per Air Force system. After peaking temporarily at 34 civilians per system in

the mid-1990s, the ratio dropped but eventually returned to this level in 2009.¹⁰ For the rank of colonel, the measure rises steadily since a low of 0.2 colonels per system in 1957 (fig. 7). By 1980 the colonel ratio had risen above 0.5 per system. Although the numbers trended downward prior to 2005, this ratio reached the highest level in 2009 at 0.7 colonels for every Air Force system. The FGs follow a nearly identical path (fig. 8). In 1957 the ratio reached a low of 1.4 FGs per system, leveled off for several decades, and then climbed constantly until it reached the current level of 5.0 FGs per Air Force system.

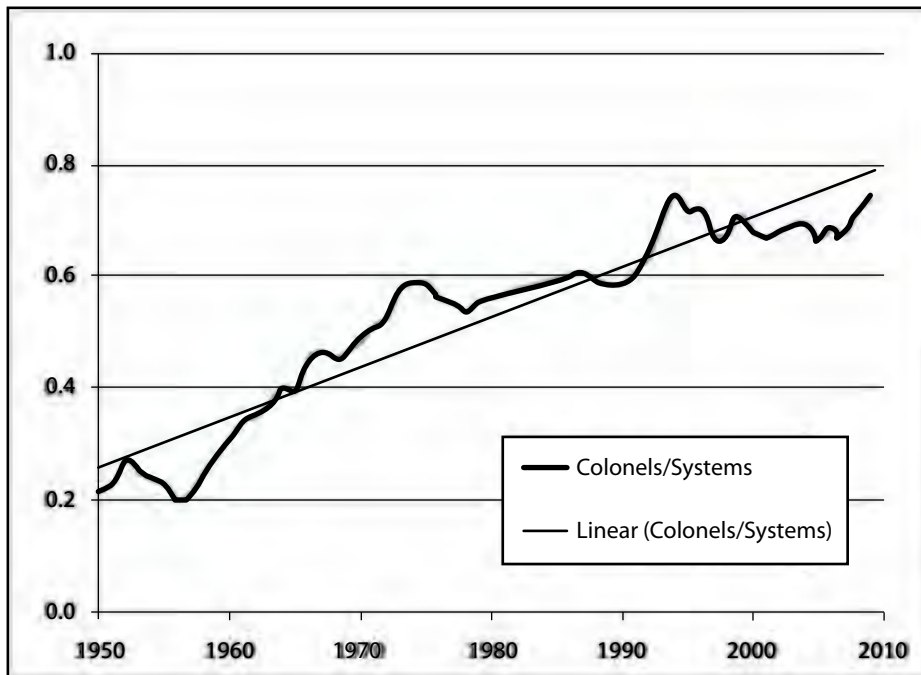

Figure 7. Colonels per Air Force system. (Data from “Air Force Strength from FY 1948–2012,” Air Force Personnel Center, accessed 9 January 2013, http://access.afpc.af.mil/vbinDMZ/broker.exe?_program=DEMOGPUB.static_reports.sas&_service=pZ1pub1&_debug=0; and James C. Ruehrmund Jr. and Christopher J. Bowie, *Arsenal of Airpower: USAF Aircraft Inventory, 1950–2009* [Washington, DC: Mitchell Institute Press, 2010], 15–26, http://www.afa.org/mitchell/reports/MS_TAI_1110.pdf.)

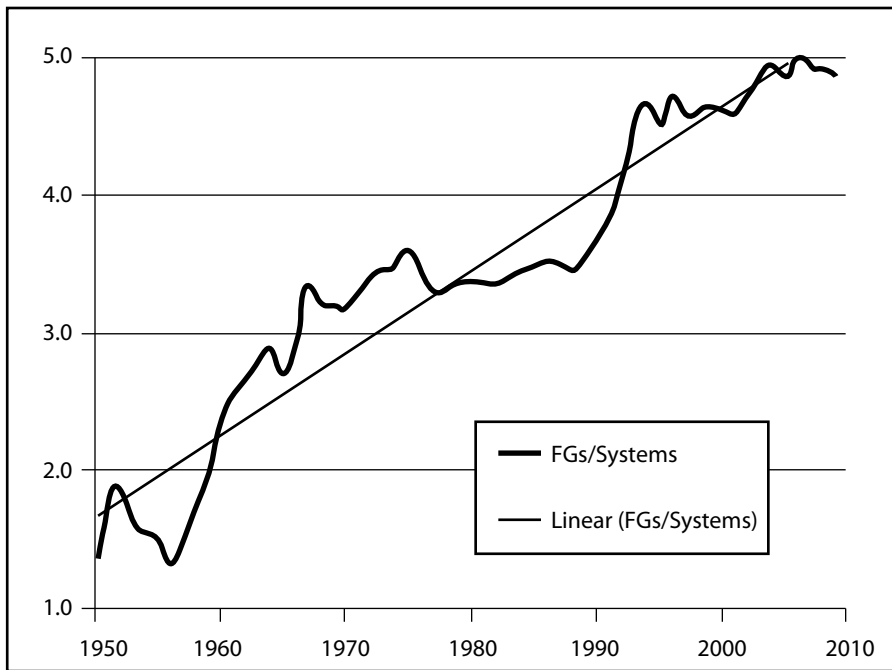

Figure 8. FGs per Air Force system. (Data from “Air Force Strength from FY 1948–2012,” Air Force Personnel Center, accessed 9 January 2013, http://access.afpc.af.mil/vbinDMZ/broker.exe?_program=DEMOGPUB.static_reports.sas&_service=pZ1pub1&_debug=0; and James C. Ruehrmund Jr. and Christopher J. Bowie, *Arsenal of Airpower: USAF Aircraft Inventory, 1950–2009* [Washington, DC: Mitchell Institute Press, 2010], 15–26, http://www.afa.org/mitchell/reports/MS_TAI_1110.pdf.)

No clear reasons exist for the increasing ratios, other than those suggested earlier for size of force. Although high-technology systems can substantiate slight gains for civilians and possibly necessitate more staff management, such factors alone cannot justify these notable trends. Neither do other possibilities—including the diversity and different types of systems, as well as operating requirements—offer a good reason for these increases. More apparently, these trends indicate overbureaucratic tendencies, as predicted by Weber and others.

The numbers speak quite clearly: the substantial growth in the number of FGs and civilians, compared to both size of force and force structure, suggests an organization overflowing with staff personnel. Most staff organizations, such as NAFs and MAJCOMs, would suggest that they have inadequate manpower, but the problem points to the possibility that too many such organizations spread the available manpower too thinly.¹¹ To address these trends, we must direct our attention to the Air Force's organizational hierarchy, looking for areas that lend themselves to reductions.

The second examination of the Air Force's organization explores its width, depth, and functionality. Specifically, width refers to the numbers of subordinate units per unit of command or how flat the structure appears. A flat organization would have several subunits one level below. Depth denotes the distance from the top of the hierarchy to the bottom. This discussion explores the depth down to wing level. However, regarding the full organizational depth, one must remember that the typical Airman in a flight works at least four levels below the wing.¹² Hence, multiple command and staff levels still remain at and below the wing. Lastly, the issue of functional commands builds upon these width and depth issues and evaluates the current functional nature of MAJCOMs.

Organizational Width and Depth

The width of an organization, also commonly referred to as span of control, describes the number of major subordinates under a single command. For Headquarters Air Force, 10 MAJCOMs represent the width, each one having a different width, varying from AFMC with 11 centers to Air Force Special Operations Command with one NAF. Excluding AFMC, MAJCOMs have one to four subordinate NAFs and centers. The number of wings subordinate to NAFs varies even more. Although Eighteenth Air Force has 14 wings or group-equivalent organizations, most NAFs have either two or three subordinate wings. The vast difference in the NAF wing allotment may suggest poor dis-

tribution and broad variations in spans of control for each NAF commander.

The varying distribution of subordinate units for the top three layers suggests that some have an overextended span of control while others remain underutilized.¹³ Superficially, it seems that opportunities exist for adjusting organizational width. However, as a prominent expert in business management cautions, flattening an organization not only should create efficiencies by stretching leaders to the extreme but also should promote in concert “democratic participation, greater efficiency, and substantially improved organizational morale.”¹⁴ These warnings deserve ample consideration in any reorganization designed to alter width, just as the width issues highlight areas that may prove fruitful in discussions about reorganization.

Inextricably connected to the issue of organizational width, the depth of a hierarchical structure generates additional issues. The Air Force created its organizational depth to manage span of control, align functions, and overcome issues of distance generated by the global positioning of air forces. The depth of the Air Force organization, from the top to wing level, consists of the four levels discussed previously. Therefore, the full organizational depth, down to the Airman, includes eight levels from top to bottom, which—though typical and prevalent—do not cover every situation within the structure. More importantly, this depth has remained steady for nearly 29 years.

During reorganizational efforts of the early 1990s, which affected both width and depth, the Air Force completely eliminated the air-division level between NAFs and wings, thereby reducing the organization from nine to eight levels. This reduction of depth—the only one in the service’s history—happened at a time when the size of force had diminished by 50 percent over a 24-year period.¹⁵ Thus, the Air Force returned to the same eight-level organizational depth established for the 1943 Army Air Forces, which boasted 2,400,000 Airmen and nearly 80,000 aircraft at its peak.¹⁶ As of 2011, just two decades after removal

of the air division, the size of force has shrunk another 30 percent, yet the same eight-level organization persists.

As is the case with width, excessive depth can create challenges for any organizational structure. For the Air Force, communications and redundancies offer two excellent examples. Prior to the age of computers, information flowed slowly, and certain types of coordination and communication were impossible over the great distances involved. Today, no limitations exist for information flowing throughout the organization. In his book *Control without Bureaucracy*, David Mitchell talks about problems with information flowing up and down an organization, noting that excessive organizational depth adversely affects the management of today's volume of information. In fact, Mitchell says that depth of the hierarchy "acts as a powerful amplifier," essentially creating an overload of information to manage.¹⁷ Practically, this is a prominent issue, given every level's need to stay informed and the overwhelming flow of reporting, correspondence, and e-mail moving into the upper echelons.

In light of the information overflow and deep hierarchy, Mitchell also points out that good ideas tend to get filtered or lost in the noise.¹⁸ Therefore, the depth of the Air Force's hierarchical organization may not allow those great ideas to flow easily from the field to the Air Staff. He also argues that the filtering effect makes it difficult for leaders to control operations strategically because condensed and summarized information does not build adequate situational awareness for educated decision making.¹⁹

Excessive redundancies may also develop, based on the organizational depth. Each level demands a certain degree of administration and redundant functions—some necessary but others wasteful and candidates for elimination. For example, every MAJCOM has a command supplement instruction to the 99-page Air Force Instruction 10-207, *Command Posts*, 1 February 2012. Air Combat Command's (ACC) supplement adds another 153 pages of instructions, Air Force Space Command's (AFSPC) 136 pages, and so on. With the service having only 73

major installations worldwide, this function could be standardized at a higher level to avoid the extra effort of creating and administering these MAJCOM-level instructions. This example is one of many since each MAJCOM produces hundreds of supplements and command instructions. Certainly, every organization has hierarchical depth and some level of duplication; however, elimination of unnecessary redundancies could generate tangible efficiencies and simplify operations.

A Functional Organization

The functional nature of MAJCOMs can further exacerbate the redundancies in different command chains created by depth. Eight US-based MAJCOMs organize functionally. A number of organizational theories address this type of functional structure, and several identify potential problems found within the Air Force organization. In particular, problems associated with functional “rice bowls” and “tribes” illustrate these issues.

Although seemingly logical and possibly easier to manage, delegating missions and responsibilities in a functional organization can present difficulties. First, the development of functional rice bowls becomes one of the most apparent issues.²⁰ Given a problem and the need to develop a capability, AFSPC will most certainly answer with a space solution while ACC will develop an aircraft-based option. American political scientist Samuel Huntington identifies this issue clearly in terms of the soldier: “He tends to stress those military needs and forces with which he is particularly familiar. To the extent that he acts in this manner he becomes a spokesman for a particular service or branch interest rather than for the military viewpoint as a whole.”²¹ Because functional commands include expert operators grown from within the command, an unhealthy competition develops among functional commands to secure limited resources, much like the competition among the different US military services.

Weber also predicts this problem with functional organizations, noting “the tendency of officials to treat their official function from what

is substantively a utilitarian point of view in the interest of the welfare of those under their authority.”²² In the Air Force, the functional MAJCOMs tend to breed and perpetuate elite corps of individuals. Maj William Thomas echoes this issue, warning about the creation of “subcultures” or “tribes” and reiterating Huntington’s concerns: “The Air Force may experience difficulties in achieving goals because members of subcultures do not remain focused on the overall goals of the organization, emphasizing instead the advancement of their specialty or of themselves.”²³

The attempt to develop a long-range-strike (LRS) capability offers a good example of what can happen within a functional structure.²⁴ Similar capability efforts considered part of this initiative include prompt global strike, the next-generation bomber, the hypersonic cruise vehicle, and the LRS system. Each of these programs, often driven by different MAJCOMs or the Air Staff, entails extraordinary exertion and tremendous amounts of funding. As the requirements process begins for the MAJCOMs, resident tribal experts in each command would certainly suggest a solution with which they are familiar. ACC would develop and submit aircraft-based solutions to the Air Staff, while AFSPC would present conventional missile system capabilities.²⁵ A MAJCOM would not only present but also champion the concept for selection and funding even though the solution may not be in the best interest of the Air Force organization or even the United States. One could argue that these functional approaches have kept the service working on developing an LRS capability development for the past 10 years yet coming no closer to a fielded solution. The presence of these rice bowls and tribes throughout the organization forces one to question whether a functional division can ensure that the Air Force reaches the overarching organizational goals in the most effective and efficient manner, given the current and anticipated global environment.

Possible Organizational Changes to the Air Force

This article now explores possibilities for changing the Air Force's current structure. After addressing recent organizational changes and historical tenets of the service, it proposes fundamental alterations that would eliminate organizational depth and consider functional challenges. Again, any attempt at reorganization must ensure no loss in the Air Force's ability to execute its mission, must improve support to global COCOMs, and must generate tangible efficiencies.

Recent Reorganizational Efforts and Official Guidance

The U.S. Air Force Transformation Flight Plan 2004 speaks of transforming the Air Force organization, proposing the use of "transformational organizational arrangements" to better carry out the mission.²⁶ One construct instituted from this wave of transformation included the war-fighting headquarters concept to support combatant commanders. These headquarters would serve as the Air Force's single voice to the combatant commander and unify air forces to accomplish the mission. Thus, each new war-fighting headquarters staff consisted of a small core of personnel to support the specific combatant commander. Although the flight plan proposed major organizational renovation, the small changes and redirections that occurred did not produce the desired transformation goals.

The *2008 Air Force Strategic Plan* continues these themes, identifying one of five priorities to "Modernize Our Air and Space . . . Organizations" and setting a specific goal to "Align Organization and Processes with Air Force Core Functions and DoD Core Competencies."²⁷ No concrete evidence suggests that changes took place as a result of this strategic plan. Though not directly linked to these strategic goals, another effort to manage the organization emerged in 2009 as the Air Force chief of staff directed unit manning minimums in the Organizational Threshold Review. Emphasizing the wing level and below, the review forced smaller units to merge and reorganize to meet these requirements.²⁸ It attempted to reorganize and consolidate units but did not

address larger Air Force structural problems whose solution would allow it to become a more effective organization, as identified in the strategic plan, mentioned above. Moreover, in 2011 the Air Force budget director announced a reorganizational proposal to consolidate four air and space operations centers and, more importantly, three NAFs.²⁹ All of these documents and efforts demonstrate concern about re-vamping the service's organization but fail to address the core issues highlighted earlier. If anything, recent actions suggest that the Air Force believes that adding new organizations (e.g., Air Force Global Strike Command and Twenty-Fourth Air Force) can fix problems. Rather than meet transformational objectives, these additions increase staff requirements, putting more strain on the shrinking size of force. Such inconsistent actions do not follow any common strategic theme, which should exist in published guidance.

Several key Air Force documents deal with the organizational structure: Air Force Doctrine Document (AFDD) 2, *Operations and Organization*, 3 April 2007; Air Force Pamphlet (AFPAM) 38-102, *Headquarters United States Air Force Organization and Functions*, 1 January 2004; Air Force Instruction (AFI) 38-101, *Air Force Organization*, 16 March 2011; and Air Force Policy Directive (AFPD) 38-1, *Organization and Unit Designations*, 24 August 2011. For the most part, AFDD 2 builds upon basic Air Force doctrine by expanding on the commanding and organizing of air and space forces, including key roles and responsibilities. AFPAM 38-102, although dated 2004, supplies details about the basic Air Staff organization and functions. Both of these documents, as well as AFI 38-101, provide thorough background information and specific requirements concerning the service's current organizational structure.

Further adding to these requirements, AFI 38-101 includes guidance regarding how the organization should structure itself, laying out four organizational principles: emphasis on wartime tasks, functional grouping, lean organizational structures, and a skip-echelon structure. Emphasis on wartime tasks should remain at the forefront of all organizational designs. (This article addressed functional grouping earlier,

and the need for a skip-echelon structure suggests an organization with excess depth.) The discussion of lean organizational structure highlights the need for a flatter makeup with minimal layers:

Organizations must encourage rapid decision making, so they should be flat structures without intermediate levels, unless mission requirements cannot otherwise be met. . . . Organizational levels that exist only to review and transmit information or tasking should be eliminated. Both the number of supervisors and the number of internal subdivisions within organizations should be designed to minimize layers and maximize worker-to-supervisor ratios.³⁰

Further, AFPD 38-1 outlines more organizational principles (examined in the following section) that build upon those in AFI 38-101. Overall, even though some guidance exists for the organizational structure, the Air Force maintains the freedom to design and develop an organization to meet the mission. Before discussing organizational change, one must understand and preserve the service's culture and traditions when possible.

Organizational Tenets: Maintaining Air Force Traditions/Principles

Over the history of aviation forces in the US military, different principles for the new and evolved organizations rang true for leaders. In the early years, the War Department directed several of these Air Force organizational themes that resonate from the service's history. Any future organizational changes must maintain these principles in order to capture important historical lessons and cultural traditions. The principles and historical tenets directed by the War Department have shaped the Air Force organization of today. In accordance with AFPD 38-1, the service continues to restate a number of them (see table below). Along with the characteristics currently identified in Air Force directives, they represent a solid foundation on which to base future organizational changes.

Table. Historical and modern organizational principles of the Air Force

<i>Historical Organizational Principles</i>	<i>Modern Organizational Principles</i>
Concentration of Airpower	Mission Orientation
Unity of Command	Unambiguous Command
Decentralization	Decentralization
Simplicity	Simplicity
Flexibility	Flexibility
Research and Development / Intelligence	Agility
Joint Coordination	Standardization

Source: AFPD 38-1, *Organization and Unit Designations*, 24 August 2011, 2, <http://www.e-publishing.af.mil/shared/media/epubs/AFPD38-1.pdf>; and Circular no. 138, *War Department Reorganization*, 14 May 1946, 3.

Reorganization Proposal

If the Air Force considers a radical reorganization, the challenges and principles highlighted earlier suggest a few approaches, the first of which would decrease organizational depth. Assuming that the Air Staff and wings remain, eliminating a layer would necessitate removal of either MAJCOMs or NAFs. The second would reduce organizational width by combining units. As seen in the Organizational Threshold Review of 2009 and recent efficiency measures taken by the Air Force, this option constitutes the “main effort” to date in reorganization. Lastly, a combination of consolidation and elimination of width and depth, although a more aggressive approach, could bring about more synergistic organizational effects and greater efficiencies.

The suggestion discussed hereafter utilizes the third approach by removing the MAJCOM level while also consolidating certain functions and units. This new organization still contains functional commands, but most of them directly support specified COCOMs. Nevertheless, a conceptual model of this proposed organization primarily takes on a regional focus along COCOM lines (fig. 9), resulting in a much flatter organization with 13 NAFs, AFMC, and Air Force Reserve Command reporting directly to Headquarters Air Force. The following clarifies a few points of liberal consolidation: Second Air Force replaces Air Edu-

cation and Training Command. In Europe, Eighth Air Force would replace US Air Forces in Europe and absorb Third Air Force. Thirteenth Air Force replaces Pacific Air Forces and gains Fifth Air Force, while First Air Force absorbs Eleventh Air Force. Given an active Korean theater, maintaining Seventh Air Force seems a logical choice and an example of creating additional NAFs to support specific missions and command structures.

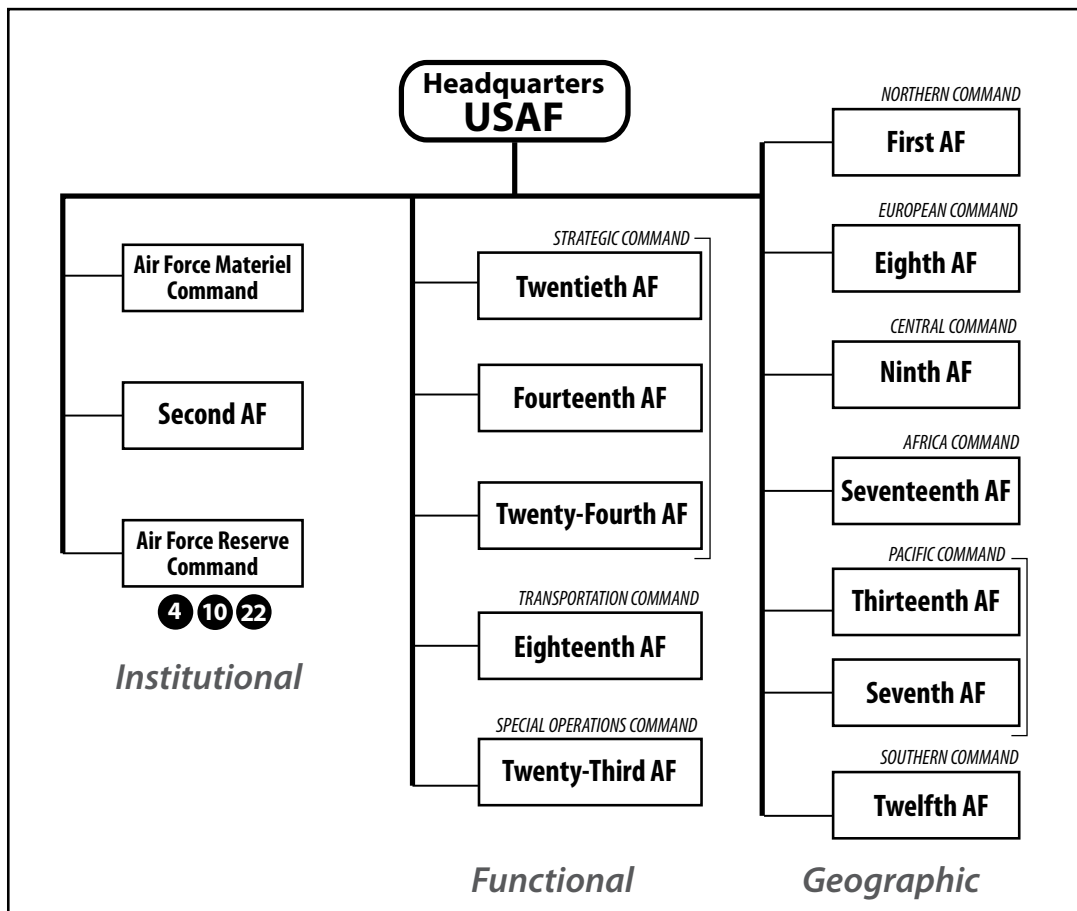

Figure 9. Proposed Air Force reorganization

The motivation to keep NAFs rather than MAJCOMs proceeds from four factors, based principally on the need to focus the organization geographically. First, with the elimination of one layer, the strategy should emphasize the primary customer—COCOMs. A geographical split of the organization makes sense in terms of orienting the organization globally and improving the capability to support COCOMs. Several sources, including title 10 and the *Unified Command Plan* of 2011, point to the benefits of a command and control relationship with forces assigned geographically: “Except as otherwise directed . . . all forces operating within the geographic area of responsibility assigned to a combatant command . . . will be assigned or attached to and under the command of that commander.”³¹ Carl Builder, a former RAND military expert, also identified this strategy in an article about the need to shift the Air Force organization regionally toward the COCOMs, thereby better preparing the service for future crises and conflicts.³²

Adding more justification, this type of structure—by dedicating NAFs assigned to COCOMs—automatically creates a commander of Air Force forces and a joint force air component commander standing in place with committed air and space operations centers to execute operations in accordance with Air Force doctrine.³³ Essentially, this situation exists today, but the arrangement would solidify and simplify the command and control function. Given a more robust staff, each NAF should also have adequate manpower to manage the full spectrum of doctrinal duties without augmentation, as is often required today. Additionally, NAF staffs would also manage some level of responsibility for organizing, training, and equipping.

The second factor should ensure that the Air Force structure can rapidly adapt and flex to meet the changing, complex global environment. One of two conclusions of 2010’s *Quadrennial Defense Review Report* identifies this requirement: “The second theme to emerge from [the review’s] analyses is the importance of ensuring that U.S. forces are flexible and adaptable so that they can confront the full range of challenges that could emerge from a complex and dynamic security

environment.”³⁴ A seemingly obvious statement for operational forces, this should also apply to the staff functions and organizations. Implementing a more streamlined organization and having the NAFs report directly to Headquarters Air Force should allow the Air Staff to better coordinate and deconflict these issues more quickly and address Air Force requirements across the entire globe.

Also emphasized in the *National Security Strategy*, *National Military Strategy of the United States of America*, and *Quadrennial Defense Review Report* of 2010, one of the key military missions concerns theater security cooperation—the third factor. These three strategic guiding documents stress the need to strengthen international security, build the capacities of partner states, and promote peace through international order.³⁵ More specifically, the chairman of the Joint Chiefs of Staff directs responsibilities for all forces and COCOMs: “The Joint Force, Combatant Commanders, and Service Chiefs shall actively partner with other U.S. Government agencies to pursue theater security cooperation to increase collective security skills with a wider range of partners.”³⁶ Without a doubt, a regionally focused organization must develop to meet these key strategic needs—an organization that can better cultivate a staff with the necessary cultural and area expertise.

The fourth factor needs little explanation since maintaining tradition and culture should pervade any reorganizational effort. As highlighted earlier, cultural principles and history should remain prevalent and carry on the Air Force’s traditions. For instance, the tremendous accomplishments and rich history of Eighth Air Force, exemplified in the European theater during World War II, can carry on as part of a dedicated NAF to US European Command.

Eliminating a layer in the organization should produce benefits for the Air Force. Where possible, devolving functions from MAJCOMs to NAFs (and avoiding duplication in the process) will permit decentralized execution for direct support of key customers—the COCOMs. Additionally, removal of an entire level will free those staff positions to bolster Headquarters Air Force as well as the NAFs and wings, allow

the elimination of significant staff manpower, and generate savings. To realize measurable savings, the Air Force should initiate a substantial overall reduction in staff manpower rather than play a shell game that simply moves manpower around to new locations. Increasing the size of staffs at the remaining top three levels (a necessity, given additional organizational responsibilities) may necessitate a more robust general staff model to redesign the Air Staff.

The Air Force chief of staff needs a larger staff, especially in light of a greater span of control and flatter organizational hierarchy, to work the vast issues that do not demand intimate commander involvement and to control cross-coordination efforts. Therefore, should reorganization do away with one level of the hierarchy, the service must add personnel to Headquarters Air Force and develop the appropriate staff structure with professionals, both military and civilians, in order to properly support the new Air Force organization.

Conclusions

Today's Air Force finds its force structure and manning at all-time lows, yet staffing positions have increased disproportionately over the past 60 years. To reverse this trend, reduce organization depth, move away from functional commands, simplify the structure, and create necessary efficiencies, the Air Force should consider removing the MAJCOMs and promoting the NAFs subordinate to Headquarters Air Force. A primarily geographic restructuring will permit the service to best support the most important customers—the combatant commanders. Additionally, regionally focused NAFs will improve theater security and adapt more quickly to complex global conflicts and conditions.

The Air Force must fund critical capabilities and programs, yet it faces a number of budgetary pressures, both external and internal. The difficult task of finding effective strategies to create the necessary efficiencies demands genuine institutional introspection. Given its current composition, the service must consider a reorganization strategy

for the top-level structure that will cut the bureaucracy and create a more efficient, adaptive, and effective organization. The Air Force should wholeheartedly consider reorganization by eliminating the MAJCOMs, thereby elevating the NAFs and becoming more geographically oriented and better suited to support the US COCOMs. Ultimately, reorganization should generate the considerable financial savings needed in today's constrained environment and maintain the critical airpower principles and traditions for a more effective war-fighting Air Force. ★

Notes

1. "The Air Force in Facts and Figures: 2010 USAF Almanac," *Air Force Magazine* 93, no. 5 (May 2010): 56, http://www.airforce-magazine.com/MagazineArchive/Magazine%20Documents/2010/May%202010/0510facts_figs.pdf; and "USAF Almanac: The Air Force in Facts and Figures," *Air Force Magazine* 83, no. 5 (May 2000): 58, http://www.airforce-magazine.com/MagazineArchive/Magazine%20Documents/2000/May%202000/0500facts_figs.pdf. Measured in constant dollars, the Air Force's baseline budget declined in 2010 by 5.22 percent from the previous year. It declined by 7.52 percent in 1994. The DOD's projected budget for 2011, also measured in constant dollars, will decrease by 8.85 percent. The last DOD budget decrease greater than this (12.8 percent) occurred in 1991. Office of Management and Budget, *Historical Tables: Budget of the U.S. Government, Fiscal Year 2010* (Washington, DC: Office of Management and Budget, 2009), 123–26, <http://www.gpo.gov/fdsys/pkg/BUDGET-2010-TAB/pdf/BUDGET-2010-TAB.pdf>.

2. *United States Code*, Title 10: Armed Forces. Title 10 of the *United States Code* provides the legal basis for the roles, missions, and organization for the DOD and each of the armed services.

3. *Ibid.*, 60–62. In 2010 the Air Force maintained just over 4,000 aircraft in the active duty inventory and another 1,500 with the Air National Guard and Air Force Reserve units. Intercontinental ballistic missiles stand at 450 systems, and 52 satellites fly under Air Force control.

4. For example, the two world wars sparked massive production of aircraft and increases in service organizations. Additionally, the Soviet Union's development of nuclear weapons and the ensuing Cold War created new organizations to manage new capabilities. Lastly, as seen most recently, budget priorities and pressures forced reductions in the acquisition of F-22 aircraft.

5. "Public Session: Defense Business Board Quarterly Meeting, July 22, 2010," 9, <http://dbb.defense.gov/pdf/Reducing%20Overhead%20and%20Improving%20Business%20Operations.pdf>. Regarding the DOD's contractor force, Mr. Arnold Punaro notes that "it is impossible for any leadership to control costs and manage personnel if they don't know how

many people work for them. . . . The Department is as frustrated as we are since there seems to be no precise answers. Under Secretary Carter just signed-out a document that pegs the number of contractors at approximately 766,000 at a cost of about \$155 billion. This exceeds the 745,000 civil service workforce. This does not include the intelligence organizations" (ibid.).

6. "Air Force Strength from FY 1948–2012," Air Force Personnel Center, accessed 9 January 2013, http://access.afpc.af.mil/vbinDMZ/broker.exe?_program=DEMOGPUB.static_reports.sas&_service=pZ1pub1&_debug=0; and "DoD Employment by Organization and Function" [see FY 2002–FY 2009] and "DoD Civilian Strength—Fiscal Years 1950–2001" [see table], accessed 31 January 2011, <http://siadapp.dmdc.osd.mil/personnel/CIVILIAN/CIVTOP.HTM>.

7. In view of the large number of contractor-to-civilian-personnel conversions, the 2012 projected total is more than 185,000 civilians. Therefore, all of the following calculations could indicate an even greater impact on the organization. Air Force Association, "USAF Almanac, 2011," May 2012.

8. Air Force Association, "USAF Almanac, 1980," May 1980; "2010 USAF Almanac"; and "Air Force Strength from FY 1948–2012."

9. Max Weber, *On Charisma and Institution Building* (Chicago: University of Chicago Press, 1968), 67.

10. Because the Air Force's civilian total for 2012 is expected to pass 185,000, the civilian ratio will increase to an all-time high. "USAF Almanac, 2011." The main drivers for civilian end-strength increases are contractor-to-civilian conversions; joint basing; acquisition excellence; intelligence, surveillance, and reconnaissance; fitness assessment cells; and war-fighter and family services.

11. A documented RAND briefing suggests that NAFs do not have adequate manpower to manage future conflicts. Lawrence M. Hanser, Maren Leed, and C. Robert Roll Jr., *The War-fighting Capacity of Air Combat Command's Numbered Air Forces*, documented briefing ([Santa Monica, CA:] RAND, 1998), viii, http://www.rand.org/content/dam/rand/pubs/documented_briefings/2005/RAND_DB297.pdf. In the spring of 2009, the Air Force Personnel Center filled only 75 of 1,450 rated, active duty officer staff positions—a vivid sign of manning disparity. Briefing, subject: AFPC "Road Show," Nellis AFB, NV, November 2008, slide 12.

12. Below the wing, the hierarchy continues down to the group, and then the squadron, and lastly the flight.

13. MAJCOM examples include AFMC with 11 centers as opposed to Air Force Special Operations Command with one NAF. For NAF examples, Eighteenth Air Force has 14 wings, and First Air Force has no wings.

14. Lyndall F. Urwick, "The Manager's Span of Control," *Harvard Business Review* 34 (May–June 1956): 47.

15. Air Force active duty personnel numbered just over 900,000 in 1968 and stood at 465,000 in 1992, 24 years later. Air Force Personnel Center, "Air Force Strength from 1948 thru 2010."

16. Alfred Goldberg, ed., *A History of the United States Air Force, 1907–1957* (Princeton, NJ: Van Nostrand, [1957]), 49.

17. David Mitchell, *Control without Bureaucracy* (London: McGraw-Hill, 1979), 54.

18. Ibid., 65.

19. Ibid., 72.
20. Generically, the term *rice bowls* refers to coveted or internally protected departments, projects, and so forth.
21. Samuel P. Huntington, *The Soldier and the State: The Theory and Politics of Civil-Military Relations* (Cambridge, MA: Belknap Press of Harvard University Press, 1957), 67.
22. Max Weber, *The Theory of Social and Economic Organization*, trans. A. M. Henderson and Talcott Parsons, ed. Talcott Parsons (New York: Free Press, 1947), 340.
23. Maj William C. Thomas, "The Cultural Identity of the United States Air Force," *Chronicles Online Journal*, 30 January 2004, <http://www.airpower.au.af.mil/airchronicles/cc/thomas.html>.
24. Gen Norman Schwartz, former Air Force chief of staff, defined the LRS capability in a speech at an Air Force Association conference in 2010: "An Air Force core contribution that combines multiple systems to provide the Nation with the capability to overcome area-denial measures, penetrate contested airspace and networks, and assure freedom of action to deliver air, space, and cyber power effects." Gen Norton Schwartz (keynote speech, Air and Space Conference, Air Force Association, 14 September 2010), 11, <http://www.af.mil/shared/media/document/AFD-100914-056.pdf>.
25. For an excellent summary of ACC's efforts to pursue a bomber study while AFSPC conducts a similar analysis on its conventional intercontinental missile system, known as Prompt Global Strike, see Marc Selinger, "USAF Eyes Study on Long-Range Strike," *Aviation Week*, 3 October 2005.
26. Department of the Air Force, *The U.S. Air Force Transformation Flight Plan 2004* (Washington, DC: Deputy Chief of Staff for Plans and Programs, Department of the Air Force, 2004), 37, <http://www.dtic.mil/cgi-bin/GetTRDoc?AD=ADA440807&Location=U2&doc=GetTRDoc.pdf>.
27. Department of the Air Force, *2008 Air Force Strategic Plan* (Washington, DC: Department of the Air Force, October 2008), 8, 9, <http://cpc.au.af.mil/PDF/2008%20Air%20Force%20Strategic%20Plan,%20Oct%202008.pdf>.
28. Department of the Air Force, *Organizational Threshold Review Memorandum*, 17 August 2009, includes guidelines for a wing, group, and squadron, requiring a minimum threshold of 1,000, 400, and 35 Airmen, respectively. Units not meeting these minimums had to dissolve, often transitioning to a lower echelon or merging with other units to meet the threshold.
29. Air Force News Service, "Efficiencies, Balance Main Focuses of FY12 Budget," 14 February 2011, <http://www.af.mil/news/story.asp?id=123242539>. Since further details were not yet available for consideration, they will not factor into the reorganization proposal.
30. Air Force Instruction 38-101, *Air Force Organization*, 16 March 2011, 6, <http://www.e-publishing.af.mil/shared/media/epubs/AFI38-101.pdf>.
31. Secretary of Defense, *Unified Command Plan—06 April 2011* (Washington, DC: Secretary of Defense, 12 September 2011), 2.
32. Carl H. Builder and Theodore W. Karasik, *Organizing, Training, and Equipping the Air Force for Crises and Lesser Conflicts* (Santa Monica, CA: RAND, 1995), 29, http://www.rand.org/content/dam/rand/pubs/monograph_reports/2006/MR626.pdf.
33. Air Force Doctrine Document 2, *Operations and Organization*, 3 April 2007, ix, <http://www.e-publishing.af.mil/shared/media/epubs/afdd2.pdf>.

34. Department of Defense, *Quadrennial Defense Review Report* (Washington, DC: Department of Defense, February 2010), 18, <http://www.defense.gov/qdr/qdr%20as%20of%2026jan10%200700.pdf>.

35. "Strengthening international and regional security requires that our forces be globally-available, yet regionally-focused." Joint Chiefs of Staff, *The National Military Strategy of the United States of America* (Washington, DC: Joint Chiefs of Staff, 2011), 10, <https://acc.dau.mil/adl/en-US/425505/file/55897/2011%20National%20Military%20Strategy.pdf>.

"Build the security capacity of partner states. . . . Building the capacity of our partners to deter and prevent conflict makes them more capable of providing assistance as we address common threats together." Department of Defense, *Quadrennial Defense Review Report*, 2, 104. The *National Security Strategy* identifies one of the key strategic approaches: "An international order advanced by U.S. leadership that promotes peace, security, and opportunity through stronger cooperation to meet global challenges." President of the United States, *National Security Strategy* (Washington, DC: White House, May 2010), 7, http://www.whitehouse.gov/sites/default/files/rss_viewer/national_security_strategy.pdf.

36. Joint Chiefs of Staff, *National Military Strategy*, 15.



Col Jeffrey P. Sundberg, USAF

Colonel Sundberg (BS, University of Colorado; MS, Naval Postgraduate School; MS, Army Command and General Staff College; MBA, University of Phoenix) serves at Headquarters North American Aerospace Defense Command–US Northern Command, Peterson AFB, Colorado. Previously, he served as an air defense aggressor squadron commander, an instructor at various assignments, and at Headquarters Air Force. A career air battle manager, he has more than 1,800 hours in the E-3 Airborne Warning and Control System. Lieutenant Colonel Sundberg is a graduate of the USAF Weapons School, Naval Postgraduate School, and the School of Advanced Military Studies' Advanced Operational Art Studies Fellowship program.

Let us know what you think! Leave a comment!

Distribution A: Approved for public release; distribution unlimited.

Disclaimer

The views and opinions expressed or implied in the *Journal* are those of the authors and should not be construed as carrying the official sanction of the Department of Defense, Air Force, Air Education and Training Command, Air University, or other agencies or departments of the US government.

This article may be reproduced in whole or in part without permission. If it is reproduced, the *Air and Space Power Journal* requests a courtesy line.

<http://www.airpower.au.af.mil>

A New Approach to Ballistic Missile Defense for Countering Antiaccess/Area-Denial Threats from Precision-Guided Weapons

Col Mike Corbett, USAF, Retired



Advanced capabilities in a variety of foreign weapon systems have prompted many discussions about antiaccess and area denial (A2AD) over the last decade. Such capabilities, which allow an adversary to apply force at greater ranges or with greater accuracy, will affect many aspects of allied campaign planning. This article addresses one subset of A2AD: the new ballistic missile technologies that an enemy can use to hold even mobile forces at risk at ranges in excess of 1,000 kilometers (km). This involves more than just China's antishipping ballistic missile—and evidence exists that other countries are developing these technologies as well.¹ If successful, they

could have a significant effect on planned missile defense systems. In particular, a maneuvering threat will have a higher probability of hitting an undefended target, place more targets at risk, and have less susceptibility to interception.

This is not a revelation—the mechanics of ballistic flight are well known. Less well known is the fact that the Missile Defense Agency (MDA) has chosen to focus nearly all resources for developing missile defense not on the A2AD threat but on the “early intercept” concept that supports the European Phased Adaptive Approach (EPAA). Since 2009 the MDA has committed most of its development efforts to improving the Navy’s SM-3 interceptor and supporting sensors. The SM-3 is an established system with a long history of success against purely ballistic targets, but it was not designed for the challenges of a maneuvering threat. Furthermore, the MDA has dedicated nearly all of its recent development to the midcourse phase of flight, where the threat has the greatest freedom to introduce confusion, and has ignored the boost and terminal phases of flight, where the threat remains most identifiable and most vulnerable.²

The maneuvering threats presented in this article are based upon foreign research that appears in English in the open technical literature. The article examines the development of simple maneuver schemes to avoid both tracking and interception and of subsequent maneuvers to hit an intended target. Such maneuvers can prove effective against midcourse interceptors with limited agility, but they have negligible effect on an agile interceptor designed for boost-phase intercepts. The analysis presented here shows that increased interceptor agility is more effective than increased speed if the threat maneuvers. It also demonstrates that the Air Force’s proposed Airborne Weapons Layer (AWL) could effectively counter these maneuvering threats.³ Finally, the article discusses whether the military services or a single-function defense agency should make the key decisions that define future operational capabilities in this critical component of air superiority.

The Missile Defense Agency's Current Plans and the Maneuvering Threat

The SM-3 family of systems, cornerstone of the MDA's development plans, was designed to intercept medium- and intermediate-range ballistic missiles in the midcourse phase of flight—assuming that decoys may be present but not maneuvers.⁴ At present, the MDA emphasizes improving the SM-3's sensor technology, discrimination algorithms, and divert-system reliability, as well as substantially boosting the interceptor's speed. This approach results in kinetic kill vehicles with low agility—low divert velocity and low lateral acceleration—and a primary concentration on increasing the effective range through higher speeds. It yields attractive, very wide area coverage from a single site but does not solve the underlying discrimination and kill-assessment issues. Moreover, if the threat maneuvers during midcourse as a countermeasure—with or without decoys—performance falls off sharply.

To fully appreciate the issues, one should understand what an adversary must do to attain this maneuvering capability and why maneuverability is so lucrative. A ballistic missile that contributes to A2AD operations must have precision guidance, to either a fixed or mobile target. The former is easier since it does not require real-time tracking, but both demand that the missile know its position (i.e., navigate), determine the difference between its actual and desired flight path (i.e., guidance), and correct to its desired flight path (i.e., control). An Iranian paper on this subject, published in 1991 by the American Institute of Aeronautics and Astronautics, indicated Iranian awareness of precision guidance techniques for intercontinental ballistic missiles (ICBM) and exposed Iran's efforts to apply these techniques to theater ballistic missiles. Iranian researchers have published subsequent papers on this subject in international journals as recently as 2008.⁵

To attack mobile targets, a medium-range ballistic missile (MRBM) (or one with longer range) must maneuver after boost phase to remove the differences in a target's position due to unpredictable motion

between time of launch and target impact. Of course, doing so calls for an off-board sensor to provide real-time tracking data on the target, but for now our attention remains on the missile. This same correction maneuver can come into play for avoidance of midcourse interception by allowing an initial flight path toward one location, followed by delayed propulsion toward the intended target. Midcourse interceptors launched at a predicted intercept point determined before the maneuver have limited flexibility to divert once their boost phase has ended. Even if they continued to track the threat through the maneuver, the end-game intercept may exceed the interceptor's divert capability. This was the subject of a Chinese paper presented at a recent guidance and control symposium hosted by the American Institute of Aeronautics and Astronautics, which also included a potentially viable Chinese approach to optimizing defense avoidance.⁶

Finally, a defensive plan that entails shooting one interceptor and assessing its success before firing others obviates the need to fire large salvos of very expensive interceptors. This "shoot-assess-shoot" doctrine led to the MDA's concept of early intercept, emphasizing the first intercept attempt during the first half of the threat's flight path.⁷ Unfortunately, such an approach necessitates tracking sensors and interceptor launch sites well forward of the defended area (or in space). This in turn requires persistent presence in the same area to which the adversary is attempting to deny access (or an exceptionally expensive constellation of space-based sensors). However, despite establishing an accurate track soon after the boost phase ends and launching an interceptor for an ascent-phase intercept, a postboost maneuver may evade its seeker acquisition or its divert capacity.

Utilizing large surface-based interceptors is not the only way to address this problem. For nearly five years now, the MDA and Air Force have jointly investigated the AWL, demonstrating critical technologies. Indeed, one test (funded by a congressional earmark rather than an MDA decision) actually carried out the MDA's first boost-phase intercept of a surrogate theater ballistic missile. Unfortunately, despite

multiple joint studies that determined the concept's technical viability and operational feasibility, the MDA has funded no further development, pursuing the EPAA instead.⁸

But is the EPAA the right concept for an antiaccess environment where threats can conduct exoatmospheric maneuvers? How does performance of the AWL compare to that of the planned EPAA systems if threats maneuver to aid penetration of the defense? What interceptor attributes are necessary for system success when the threat maneuvers? To answer these questions, the author simulated both approaches against two different threats—an exomaneuvering MRBM with terminal guidance and an ICBM capable of lofted trajectories. The following analysis included improvements in both speed and agility to a notional surface-launched interceptor, similar to the planned developments of the SM-3. The resulting performance projections were then compared to the baseline AWL upper-tier interceptor in terms of operational area.

Not surprisingly, the results indicated that the planned speed increases for the EPAA interceptor alone offered little benefit if the threat maneuvers after boost phase. Moreover, enhanced agility produced other benefits, including introduction of a boost-phase intercept capability if the interceptor launched close enough to the threat's launch site. Concurrently, the Defense Science Board's report of September 2011 regarding early intercept criticized the MDA on several accounts but acknowledged that boost-phase intercepts would solve the principal deficiencies of early intercept (discrimination and kill-assessment challenges). The board also acknowledged that boost-phase intercept with today's systems is not currently feasible.⁹ However, such intercept is feasible with more interceptor agility *and* placement of the interceptor close to the threat's launch area. Again, the key interceptor attribute is increased agility—as well as the critical positioning capability that airpower can supply—the two primary advantages of the AWL.

Finally, given the findings of the Defense Science Board, this analysis, and the MDA's decisions to pursue the EPAA and defer any development of the AWL, one must question whether a single-function de-

fense agency such as the MDA is the proper organization to decide future defense capabilities. Its formation in 2002 from the Ballistic Missile Defense Organization was driven by an administration goal to provide nationwide protection against a North Korean threat as quickly as possible. Is that approach still justified, and is it the best one for future theater challenges? Before addressing that question, I will first describe the analysis and modeling of the maneuvering threat.

Threat Models

The MRBM threat model was roughly based upon “Maneuver Strategy of Evader Considering Detection System,” a Chinese paper presented in August 2011 by Yang Guo, Shicheng Wang, Yu Yao, Baoqing Yang, and Peng Zhang at the Guidance, Navigation, and Control Conference sponsored by the American Institute of Aeronautics and Astronautics. These authors suggested multiple methods for evading interception, including single and multiple pulses (fig. 1). They note that “the purpose of maneuver is to change ballistic trajectory instead of evading interceptor directly. On the interception side, estimation and prediction errors of detection system will increase because of Ballistic Maneuver by the flight vehicle. . . . If the errors are large enough, the interceptor either fails to satisfy the launch requirements (such as target location uncertainty, capture zone), or loses the target after launch.”¹⁰

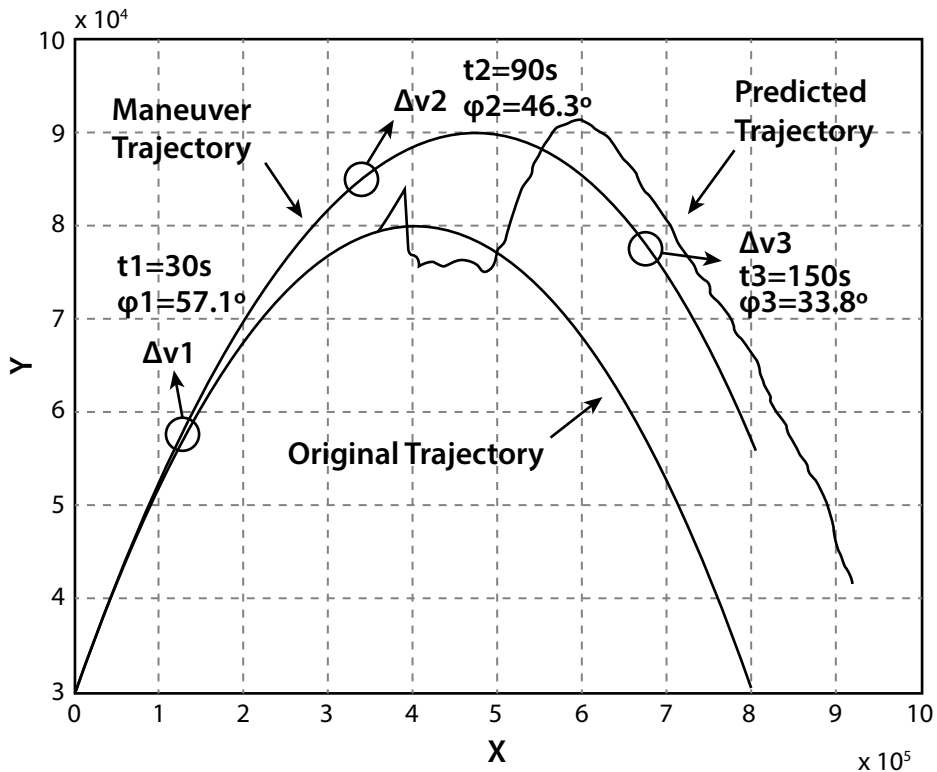

Figure 1. Trajectory of three times maneuver. (From Yang Guo et al., “Maneuver Strategy of Evader Considering Detection System,” AIAA 2011-6713 [presentation at the American Institute of Aeronautics and Astronautics Guidance, Navigation, and Control Conference, Portland, OR, 8–11 August 2011].)

The following analysis modeled one- and two-pulse maneuvers for the notional MRBM threat model (fig. 2). The maneuvers, which occur above 200 km in altitude during ascent, are barely noticeable in the following trajectory arcs but do result in the shift in impact points as depicted. For the ICBM, both a minimum-energy trajectory and a lofted trajectory were modeled (fig. 3).

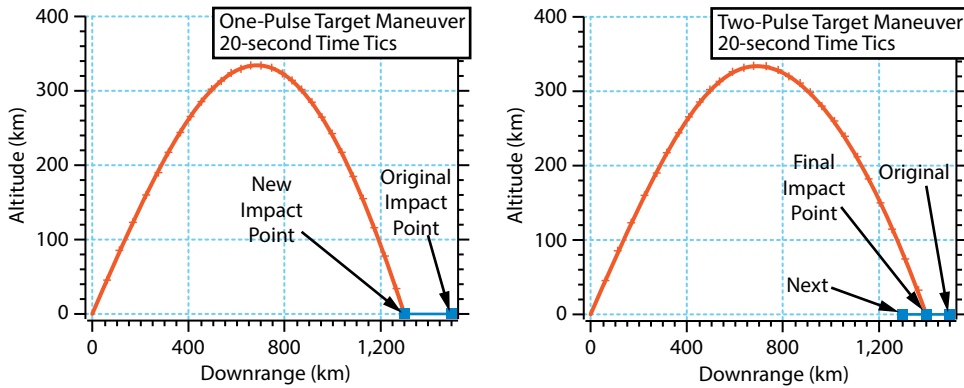

Figure 2. MRBM threat with one- and two-pulse midcourse evasion/precision-targeting maneuver

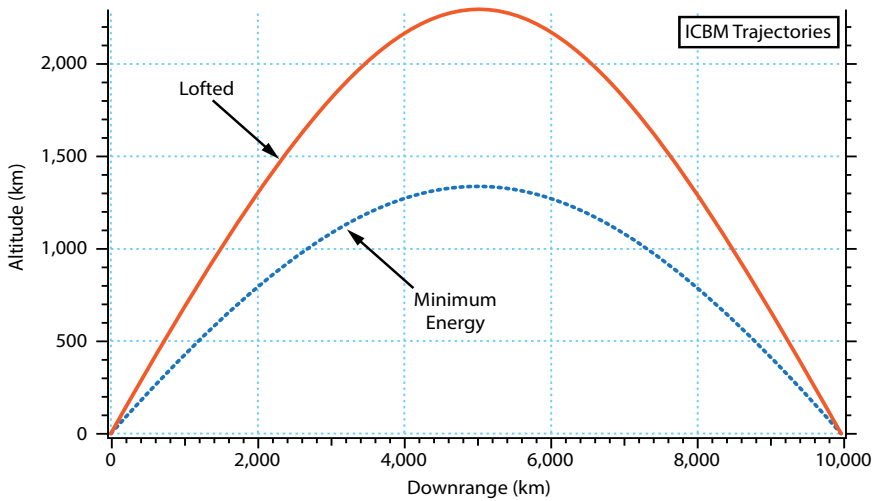

Figure 3. Comparison of minimum-energy and lofted ICBM trajectory

These maneuvers and the lofted ICBM trajectory do not occur without cost, however. An adversary cannot maneuver in flight or fly a lofted trajectory without a performance penalty to either the maximum range for delivering a particular payload or the maximum payload delivered to a particular range. The ICBM could use the additional energy necessary to fly a lofted trajectory to deliver the same payload further on a minimum-energy trajectory. If the weight of the systems needed

to execute these threat maneuvers is about 250 kilograms (a reasonable estimate), the additional weight would result in a decrease in the MRBM's maximum range from 3,000 to 2,400 km (about 20 percent). Despite these significant effects on missile range, an enemy may be willing to accept them to put his weapon on the intended target.

Interceptor Models

The notional baseline surface-launch interceptor was modeled with 3.5 km/second burnout velocity, 250 meter/second divert, acceleration of 2 g's, and homing guidance. This was considered nominal performance for a surface-launched interceptor and representative of a low-agility missile intended for midcourse intercepts only (referred to in the figures that follow as the "phased adaptive approach [PAA] surrogate"). I intend the PAA surrogate only as a point of departure for examining the potential performance benefits attainable by increasing the interceptor velocity or the kinetic kill vehicle's agility. It is not one of the variants of the SM-3.

This analysis assumes that planned forward-based radar, airborne infrared tracking systems, and the Precision Tracking Space System are all available and contribute to "perfect tracking" to support the PAA surrogate. This provides a common basis for comparison of interceptor performance but also produces overly optimistic performance estimates. Four notional developments of the PAA surrogate were modeled, with burnout velocities of 5 km/second and 6 km/second (40 percent and 70 percent faster, respectively, but with baseline agility) and with baseline velocity—but with 200 percent and then 400 percent greater agility.

The AWL upper-tier interceptor was modeled, based on employment from an F-35A.¹¹ In general the upper-tier interceptor has a burnout velocity of 3.5 km/second and a divert capability of 2.0 km/second; moreover, it is capable of 10 g's lateral acceleration. For boost and early ascent-phase intercepts, it relies only on the indigenous F-35

Distributed Aperture System and triangulation from two aircraft operating in formation.

Simulation Results: Operational Area Comparisons

Open sources describe details of the modeling system.¹² Although this article presents only the results, readers are encouraged to fully investigate the simulation methods used and decide for themselves if the methods are adequate. The objective was to determine interceptor attributes necessary for successful intercepts against maneuvering threats. The method consisted of simulating nonmaneuvering threats, adding threat maneuvers, and then examining interceptor velocity and agility enhancements to isolate the most important ones.

Figure 4 depicts the operational area for a notional 3.5 km/second interceptor against a nonmaneuvering MRBM threat. With no threat maneuvers, agility is not a distinguishing factor, and the resulting operational areas remain the same for both the AWL and the PAA surrogate. Interceptors may be launched from behind, abeam, or in front of the intended target for midcourse intercepts. However, if the intercept is constrained to occur prior to apogee (the ascent phase) to support a shoot-assess-shoot doctrine, one sees in figure 4 that for the same threat profile, each interceptor must now be launched from well in front of the defended target impact point.

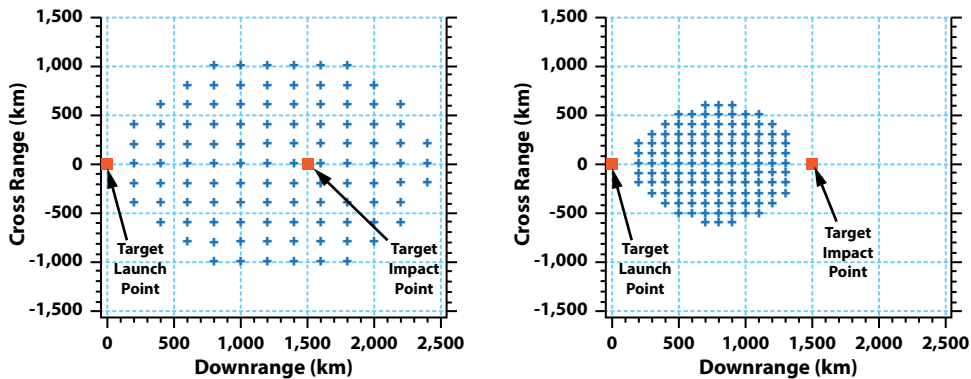

Figure 4. Operational area comparison, no threat maneuvers (left: midcourse intercepts, right: ascent phase)

Introduction of a single-pulse target maneuver significantly reduced the operational area for the PAA surrogate, but the AWL operational area remained relatively unchanged. The two-pulse threat maneuver caused the PAA surrogate to lose all intercept capability in the ascent phase; the AWL interceptor, though, retained over 90 percent of the original operational area (fig. 5, top). The speed of the PAA surrogate interceptor was then increased by 40 percent, thus producing a small operational area relatively close to the target launch point. Boosting the interceptor speed by 70 percent enlarged the operational area marginally (fig. 5, center), but it still required launch points well ahead of the defended target point. Next, the analysis kept the baseline PAA surrogate speed and doubled the agility, producing a limited operational area, which, when doubled again, grew to about 80 percent of the original area (fig. 5, bottom). However, not until the agility was increased six times the original amount did the surface-launch interceptor regain parity with the AWL. The noticeable asymmetry of these operational areas was attributed to the out-of-plane threat maneuvers.

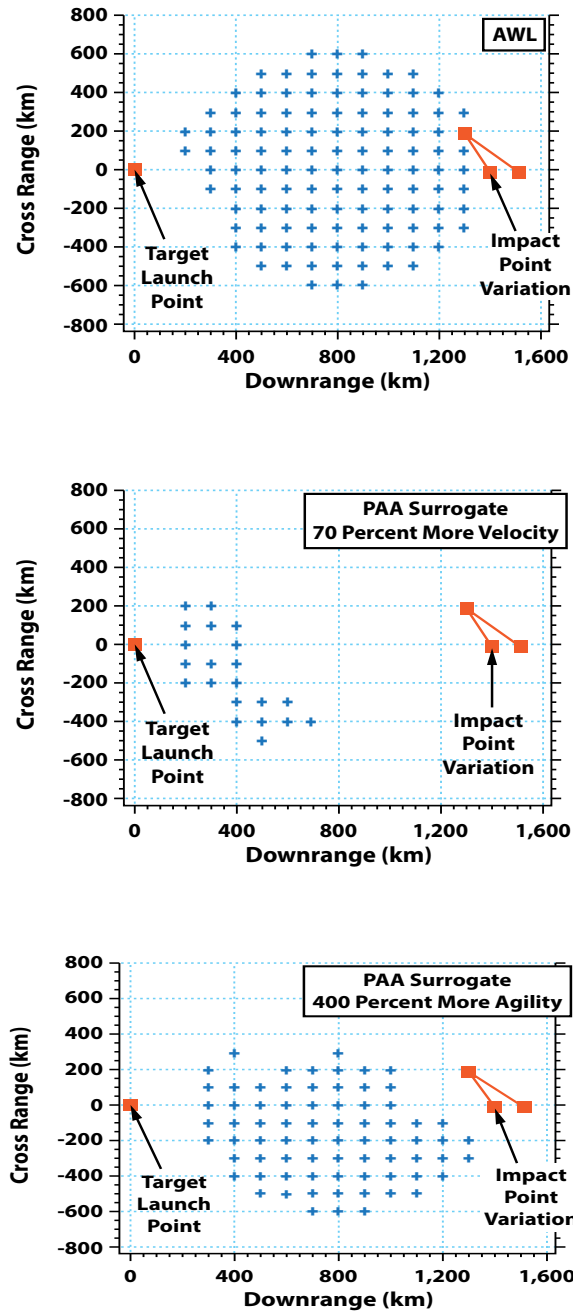

Figure 5. MRBM, two-pulse maneuver, ascent-phase intercepts only (agility versus speed)

ICBM Intercepts

Neither the AWL nor the PAA surrogate—each with a burnout velocity of only 3.5 km/second—has an ascent-phase capability against a 10,000 km ICBM on a minimum-energy trajectory. However, both will retain a descent-phase capability, given adequate tracking support. Note the change in the range scale and the AWL's descent-phase operational area of roughly 1,000 km by 1,500 km (fig. 6). However, this small operational area of the upper-tier AWL interceptor, when combined with air defense alert aircraft, allows a descent-phase layer of protection against ICBMs over the entire continental United States.

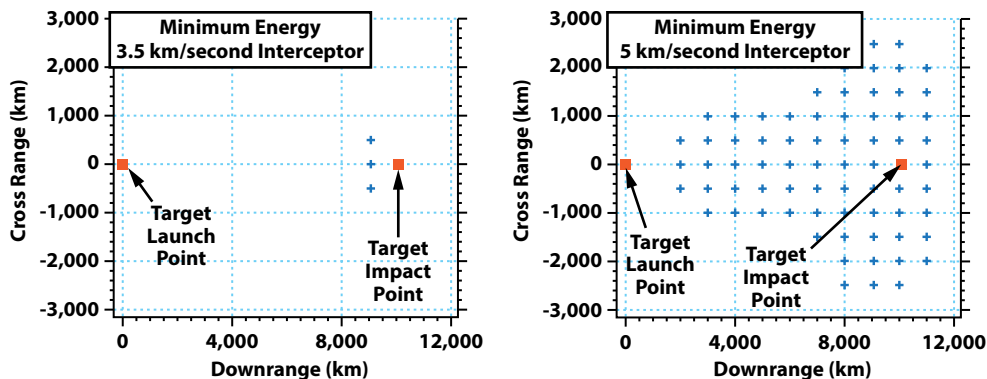

Figure 6. ICBM minimum-energy profile (comparison of 3.5 km/second interceptor to 5 km/second interceptor)

Increasing the PAA surrogate's speed by 40 percent to 5 km/second enables ICBM engagement throughout the ascent and midcourse phases, but again this assumes perfect tracking. Although this large operating area looks attractive, it only indicates that 5 km/second is sufficient kinematics to intercept a nonmaneuvering ICBM throughout the midcourse phase. Unfortunately, all problems associated with providing that perfect tracking, along with midcourse discrimination and kill assessment, remain. When the same interceptors were compared against an ICBM on a lofted trajectory, both retained descent-phase

capability, but the ascent-phase capability of the 5 km/second interceptor disappeared.

Examining the same threat for boost-phase intercept showed that the AWL will provide an operationally useful intercept capability with a significant operational area. The analysis also revealed a very limited boost-phase intercept capability for the PAA surrogate interceptor with baseline agility although that is due to the continuous guidance assumed for this analysis. If one assumes guidance initiation similar to that of today's systems, the capability vanishes. One should also note that the MDA has made no claims of a boost-phase intercept capability for the planned PAA systems. Increasing the PAA surrogate's agility by 200 percent or its speed by 40 percent did give it a limited capability for boost-phase intercepts. However, even though the size of the operational area expanded, it remained relatively close to the threat's launch point with limited cross-range capability.

A lofted ICBM trajectory reduced the AWL's boost-phase operational area by a small amount (fig. 7, left side), as well as that of the PAA surrogate with increased agility. Note that even with a burnout velocity of 6 km/second but without significantly enhanced agility, the operational area for the surrogate remains relatively close to the threat launch area and again provides very little cross-range capability (fig. 7, right side). This clearly shows that even significant augmentation of interceptor velocity does not appreciably increase the distance of the operational area from the threat's launch point. Realization of the operational limitations implied by this fact represented one of the principal factors that led to the demise of the kinetic energy interceptor program.

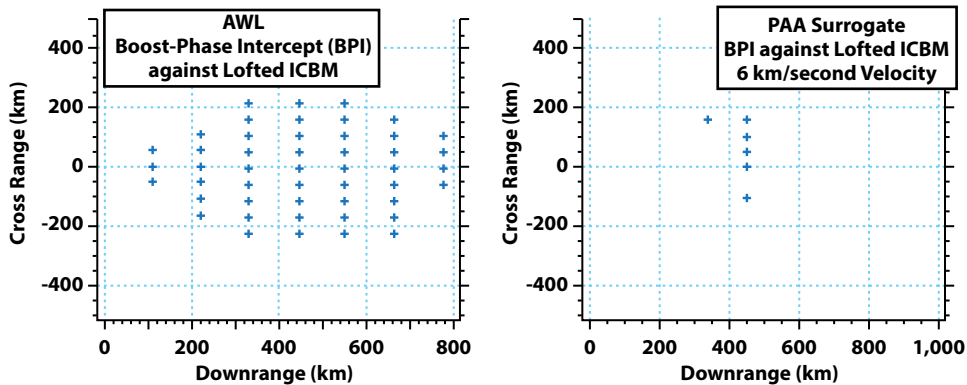

Figure 7. ICBM lofted trajectory, boost-phase intercept (comparison of the AWL to the 6 km/second PAA surrogate)

It may not be feasible to deploy surface-launched interceptors where necessary for boost-phase intercepts, but the same limitation does not apply to air-launched interceptors. Low-observable aircraft operating within 600–900 km of a suspected Iranian ICBM launch area would be feasible, commensurate with heightened tensions. Granted, maintaining persistent boost-phase intercept coverage for all potential ICBM launch sites in a country like Iran for an extended period would become overwhelming, but our forces could do so for brief periods while strike operations destroyed the launch sites.

What Does This Mean?

Gains in operational area derived from increases in interceptor speed alone fall apart quickly if the threat maneuvers. In fact, as mentioned above, all ascent-phase intercept capability disappeared with the MRBM two-pulse maneuver for the PAA surrogate. Raising the speed by 40 or 70 percent regained some marginal capability but did not restore the original operational area associated with a nonmaneuvering threat.

For ascent-phase intercepts against a maneuvering threat, the analysis indicates that defense performance, as depicted by operational

area, increased much faster with improvements to the interceptor's agility rather than to its speed. The interceptor performance needed to engage an ICBM robustly for an ascent-phase intercept will demand substantially greater interceptor velocity than the proposed SM-3 family of systems (approaching that of the originally planned European ground-based midcourse defense [GMD] deployment) and must still address the problem of effective exoatmospheric discrimination and kill assessment. For MRBM engagements with a high-speed interceptor, ascent-phase intercepts would necessitate launch areas well forward of defended areas. For ICBM ascent-phase engagements, assuming availability of a very-high-speed interceptor, the limited operational area could rule out deployment to friendly host countries or access from the sea. Further, European deployments of such an interceptor would generate concern and opposition in Russia. In contrast, the AWL retains a boost-phase capability against ICBMs from Iran and other countries, featuring an operational area that low-observable aircraft could obtain during periods of heightened tension—this in addition to a capability of autonomous terminal defense provided by the same aircraft and weapons.

Report of the Defense Science Board Task Force on the Missile Defense Agency's "Early Intercept" Concept

In December 2009, the undersecretary of defense asked the Defense Science Board to examine the science and technology issues of early intercept ballistic missile defense. Completing its review in September 2011, the board offered the following conclusions:

- “[Early intercept] in and of itself is not a useful objective for missile defense in general or for any particular missile defense system,” highly dependent on the development of a *very high-speed* regional interceptor and “predicated on an ability to discriminate (in the exo atmosphere) the missile warhead(s) from other pieces of the offensive missile complex, such as rocket bodies, miscella-

neous hardware, and intentional countermeasures. The importance of achieving reliable midcourse discrimination cannot be overemphasized.”¹³

- One of the objectives of the early intercept concept—reduced depletion of interceptor inventory by using shoot-assess-shoot doctrine to avoid salvo launches—calls for near-perfect kill assessment. Calculations revealed it would prove ineffective, given a probability of a false-positive kill assessment greater than 2 percent. The board concluded that, “unfortunately, the ability to make kill assessments with such small probabilities of false positive has yet to be demonstrated.”¹⁴ The findings also acknowledged that boost-phase intercept (assessed as currently not feasible) is a fundamental counter to the use of penetration aids or the early release of submunitions.¹⁵
- The MDA, in coordination with current service efforts, should develop future plans for “more advanced technology for regional missiles with the proper balance between higher velocity, lateral movement capability [i.e., agility], payload weight and shorter burn time and with the potential to be deployed both on land and at sea.”¹⁶

However, the Defense Science Board did not consider the implications of a maneuvering threat.

The National Research Council’s (NRC) report entitled *Making Sense of Ballistic Missile Defense: An Assessment of Concepts and Systems for U.S. Boost-Phase Missile Defense in Comparison to Other Alternatives* was released on 11 September 2012. An unclassified letter to the chairman of the House Armed Services Committee summarized the report’s findings, however:

- Phase IV of the EPAA is “not necessary for theater defense and is at best less than optimal for homeland defense. . . . With regard to . . . homeland defense, a significantly faster interceptor than needed for theater

defense would be needed to avoid a forward-located homeland defense being overflowed.”¹⁷

- “The committee [found] no valid justification for pursuing PTSS [Precision Tracking Space System]. . . . It is too far away from the threat to provide useful discrimination data. . . . PTSS would cost 2 to 3 times as much as MDA estimates.”¹⁸
- The report determined that “boost-phase intercept was not feasible, except in very limited cases,” one of which was air-launched interceptors based upon tactical aircraft “in conflict situations in which the U.S. had air supremacy, so that [these aircraft] could safely operate close to or over enemy basing areas.”¹⁹
- It recommended that the MDA focus on improving the interceptor and sensors of the GMD system—a recommendation challenged by others who believe that the report erred in its assessment of the radar cross-section of the warhead.²⁰

However, the NRC Committee also did not consider the implication of maneuvering threats.

Increased interceptor speed alone is not enough if the target maneuvers. Agility, rather than speed, then becomes the essential interceptor attribute. Agility also enables boost-phase intercepts if the interceptor can be positioned close enough to the threat launch area. This, in turn, relieves the requirement to achieve near-perfect exo-atmospheric discrimination and kill assessment necessary for a shoot-assess-shoot doctrine.

Given the same agility and speed, an air-launched interceptor and a ground-launched interceptor can both counter a maneuvering threat, but only an air-launched interceptor provides the flexibility of launch location to carry out boost-phase intercepts as well. Additionally, the AWL offers a survivable, flexible, and scalable capability, quickly deployable to a theater.

Agile kill vehicles constrained by insensitive munitions requirements represent unique but not insurmountable development chal-

lenges. Previous MDA efforts had identified promising technologies that could meet the agility objectives, but the agency terminated these efforts in 2009 to concentrate on “early intercept” and the EPAA.

Despite claims by many critics that midcourse intercepts in the presence of decoys are difficult, if not impossible, the MDA has directed most of the current development funding to enhancements to midcourse systems. The potential introduction of maneuvering threats poses even greater challenges to the systems planned for the EPAA.

Multiple studies have asserted both the technical viability and operational feasibility of the AWL, which represents an alternative to an SM-3-centered concept not hindered by midcourse discrimination concerns and brings with it the potential for significant, additional capabilities in air superiority.²¹ A lower-tier AWL interceptor is the same size and weight as an advanced medium-range air-to-air missile (AMRAAM) but potentially twice as fast (and capable of intercepting at twice the range) because it doesn't carry a warhead and relies on the kinetic energy of the impact for the kill mechanism.

The government of Israel, which understands the synergy possible with air superiority systems, is considering the development of Rafael's future air-to-air missile, based upon the upper stage of the Stunner interceptor of the Israeli David's Sling missile defense system.²² The Stunner itself had been derived from the Python air-to-air missile, and now this proposed program would apply the hit-to-kill technology to an air-to-air missile that would likely have kinematics superior to those of the AMRAAM. Since 2006 the MDA and Israel have jointly managed the David's Sling program, and the US Congress has appropriated more than \$400 million for its development.²³

An AWL upper-tier interceptor roughly the size of a 2,000-pound bomb would provide approximately the same operational-area performance as the much larger SM-3 Block 2 but without the necessary surface infrastructure. Further, it would not demand a presence on the ground in difficult regions without basing options; neither would it

need forward sensors and data communication links required by the EPAA. Nevertheless, this concept receives little support from the MDA.

The director of that agency testified before Congress on 7 March 2012 regarding the details of the president's budget for fiscal year 2013 (FY 13), which again emphasized future development of the previously planned EPAA.²⁴ Despite the findings of the Defense Science Board and the NRC, the MDA plans to continue to pursue the early intercept concept and to proceed with the proposed enhancements to the SM-3. It requested no funds to support technology development for enhanced interceptor agility, the AWL, or any specific counters to A2AD threats.

The MDA has no incentive (and some would even argue that it has no authority) to pursue systems with ancillary capabilities beyond missile defense. Its charter strictly limits the agency's authority to missile defense, regardless of the benefits of multiple-mission systems. The MDA's record indicates a willingness to use the capabilities of other systems (Aegis-equipped ships, the space-based infrared system, early warning radars, etc.) that support missile defense, but it applies development resources only to purely missile-defense functions. Dual-role systems such as Patriot and the Aegis SM-2 Block IV trace their development to decisions predating the MDA.

Even if a missile defense development would contribute significantly to the air superiority mission, the MDA has no incentive to pursue it; in fact, it would have to overcome impediments to seeking such a solution. Imagine the difficulty of a decision involving a trade-off that improved a non-missile-defense function to the detriment of a missile defense function. From the developer's perspective, the "stovepipe" single-function approach is much easier to deal with. But is this the best solution from a war fighter's perspective? Perhaps decisions with an operational impact should be left to the services rather than an engineering and development agency such as the MDA.

Conclusion

The Ballistic Missile Defense System, the world's largest single defense acquisition program, has allocated the majority of its resources in FY 12 on midcourse interceptor systems.²⁵ This excludes the development of technology that could support interceptor agility necessary for boost-phase intercepts, or possible ancillary use in a system capable of contributing to both missile defense and air superiority.²⁶ As the military departments work toward a future of predominantly multirole systems, the Department of Defense should consider whether that same way of thinking should apply to missile defense. Regarding the acquisition of weapon systems, is a single-function development agency still preferable to the military departments?

Air Force doctrine clearly includes ballistic missile defense within both offensive counterair and defensive counterair mission areas, but the necessary Air Force capabilities do not exist following the launch of a ballistic missile. At that point, all active defense capability lies only with surface-launched systems, most of which rely on midcourse intercepts. Accepting that posture entails significant risk—without a layered defense and without boost or mobile terminal-phase intercept capabilities—as threat capabilities advance. Unfortunately, the MDA program does not address that risk.

Diverting only 1 percent of the MDA's obligation authority in 2013 would establish a foundation for initiating an Air Force or joint AWL program office. Increasing that diversion over a five-year period to no more than 10 percent of that agency's annual obligation authority would enable the efficient development and acquisition of both upper- and lower-tier interceptors, as well as full integration of the F-35 for the Air Force, Navy, and Marine Corps.²⁷ By the end of the decade, active missile defense capability could become fully integrated into air superiority operations within the combat air forces, giving us the tools we need to match the doctrine of integrated air and missile defense.

Time and again, the services have proven that they can balance the needs of the moment with those of the future. They have the capability to direct resources in an environment of competing requirements and can apply the needs of the war fighter to the acquisition of weapon systems. The Department of Defense's senior leadership should give them the opportunity to guide the development of the AWL with missile defense resources.

Doctrine, in general, also acknowledges that despite our best attempts, we don't always get it right the first time: "A defining element in military effectiveness lies in the ability to recognize when prewar visions and understanding of war are flawed and must change."²⁸ If the long-term viability of midcourse intercepts is in doubt, then we should consider alternatives that avoid that liability or at least mitigate the risk. Some resources should focus on developing reasonable choices and providing decision makers with a true analysis of them. Placing the AWL under service leadership is an excellent way to begin—and the time to act is now. 🌟

Notes

1. For published foreign research into the defensive maneuvering of ballistic missiles, see Yang Guo et al., "Maneuver Strategy of Evader Considering Detection System," AIAA 2011-6713 (presentation at the American Institute of Aeronautics and Astronautics Guidance, Navigation, and Control Conference, Portland, OR, 8–11 August 2011) (accepted for publication as "Maneuver Control Strategies to Maximize Prediction Errors in Ballistic Middle Phase" in the AIAA's *Journal of Guidance, Control, and Dynamics*); J. Z. Ben-Asher, "The Influence of a Maneuvering Target RV on Radar Predictions" (paper presented at the 7th International Conference on Missile Defence: Challenges in Europe, Spain, May 2011); and Erez Druckmann and J. Z. Ben-Asher, "Optimal In-Flight Trajectory Modifications for Ballistic Missile and Free Rockets," *Journal of Guidance, Control, and Dynamics*, 2013, forthcoming. Additionally, nontechnical open-source literature refers to maneuvers for defense avoidance by India's Prahaar system and Pakistan's Shaheen 1, 1A, and 2. See *Wikipedia: The Free Encyclopedia*, s.v. "Prahaar (missile)," http://en.wikipedia.org/wiki/Prahaar_%28missile%29; and *Wikipedia: The Free Encyclopedia*, s.v. "Shaheen-1," <http://en.wikipedia.org/wiki/Shaaheen-1>.

2. The MDA budget request has included funds for laser research with the remnants of the Airborne Laser (ABL) program and some promising but nascent technology development. However, since the ABL program was terminated because of the lack of a viable boost-phase-intercept concept of operations, among other reasons, it is a dubious claim that the continued research addresses development of the boost and terminal-intercept phase.

3. The AWL operational concept is thoroughly described in the author's previous articles with Paul Zarchan. See Col Mike Corbett and Paul Zarchan, "The Role of Airpower in Active Missile Defense," *Air and Space Power Journal* 24, no. 2 (Summer 2010): 57–71; and Corbett and Zarchan, "The United States Should Develop a Missile Defense System That Builds Confidence," *Air and Space Power Journal* 25, no. 3 (Fall 2011): 74–90.

4. Ronald O'Rourke, *Navy Aegis Ballistic Missile Defense (BMD) Program: Background and Issues for Congress*, CRS Report for Congress (Washington, DC: Congressional Research Service, 18 March 2012), 3–5.

5. Mohammad-Ali Massoumnia, *Q-Guidance in Rotating Coordinates*, AIAA-91-2784-CP (Reston, VA: American Institute of Aeronautics and Astronautics, 1991).

6. Yang Guo et al., "Maneuver Strategy."

7. Defense Science Board, *Defense Science Board Task Force Report on Science and Technology Issues of Early Intercept Ballistic Missile Defense Feasibility* (Washington, DC: Defense Science Board, September 2011), 9–12, <http://www.acq.osd.mil/dsb/reports/ADA552472.pdf>.

8. *Unclassified Statement of Lieutenant General Patrick J. O'Reilly, Director, Missile Defense Agency, before the House Armed Services Committee Subcommittee on Strategic Forces Regarding the Fiscal Year 2013 Budget Request, Tuesday, March 6, 2012*, http://armedservices.house.gov/index.cfm/files/serve?File_id=6fc80696-e878-49cb-b429-7a5b72fca2d4.

9. Defense Science Board, *Defense Science Board Task Force Report*, 9.

10. Yang Guo et al., "Maneuver Strategy."

11. Corbett and Zarchan, "Airpower in Active Missile Defense," 57–71.

12. Paul Zarchan, "Kill Vehicle Guidance and Control Sizing for Boost-Phase Intercept," *Journal of Guidance, Control, and Dynamics*, March–April 2010, 513–21.

13. Defense Science Board, *Defense Science Board Task Force Report*, 33, 8.

14. *Ibid.*, 11.

15. *Ibid.*, 9.

16. *Ibid.*, 34.

17. L. David Montague, cochair; and Walter B. Slocombe, cochair; NRC Committee on an Assessment of Concepts and Systems for US Boost-Phase Missile Defense in Comparison to Other Alternatives, to Rep. Michael R. Turner, chairman, Strategic Forces Subcommittee, House Armed Services Committee, letter, 30 April 2012, 2, http://hosted.ap.org/specials/interactives/documents/nas_response.pdf.

18. *Ibid.*, 2, 3.

19. *Ibid.*, 4, 5.

20. George N. Lewis and Theodore A. Postol, to Rep. Michael R. Turner, chairman, Strategic Forces Subcommittee, House Armed Services Committee, and Rep. Loretta Sanchez, ranking member, House Armed Services Committee, letter, 20 August 2012.

21. Corbett and Zarchan, "Defense System That Builds Confidence," 77.

22. Bill Sweetman, "Real Money," *Aviation Week and Space Technology* 174, no. 11 (19/26 March 2012): 70.

23. Jeremy M. Sharp, *U.S. Foreign Aid to Israel*, CRS Report for Congress (Washington, DC: Congressional Research Service, 12 March 2012), 15, http://assets.opencrs.com/rpts/RL33222_20120312.pdf.

24. *Unclassified Statement of Lieutenant General Patrick J. O'Reilly.*

25. Government Accountability Office, *Missile Defense: Actions Needed to Improve Transparency and Accountability*, GAO-11-555T (Washington, DC: Government Accountability Office, 13 April 2011), 1, <http://www.gao.gov/assets/130/126047.pdf>.

26. "MDA Fiscal Year 2012 Budget Outline," accessed 3 December 2012, <http://www.mda.mil/global/documents/pdf/budgetfy12.pdf>; and "Missile Defense Agency (MDA) Fiscal Year 2013 Budget Outline," accessed 3 December 2012, <http://www.mda.mil/global/documents/pdf/budgetfy13.pdf>.

27. The MDA's total obligation authority in FY 12 was \$8.419 billion, 1 percent of which (\$85 million) would support establishment of a joint program office and initial technology development. Increasing the annual allocation to 10 percent (\$850 million) over the next five years would provide funding that has proven sufficient to develop systems of similar size and complexity. Eugene L. Fleeman's *Tactical Missile Design* (Reston, VA: American Institute of Aeronautics and Astronautics, 2001) shows the actual cost of 21 different system design and development phases for tactical missiles (p. 285). However, precise development costs would remain a rough estimate until the completion of preliminary designs.

28. Air Force Doctrine Document 1, *Air Force Basic Doctrine, Organization, and Command*, 14 October 2011, viii, <http://www.e-publishing.af.mil/shared/media/epubs/afdd1.pdf>.



Col Mike Corbett, USAF, Retired

Colonel Corbett (BS, Oregon State University; MS, Purdue University; MS, Auburn University–Montgomery) served as the assistant system program director for the Geostationary Operational Environmental Satellite R-Series (GOES-R), a \$10.86 billion weather satellite acquisition program of the National Oceanic and Atmospheric Administration prior to his retirement in October 2012. From 2006 through 2009, he served as the Missile Defense Agency's (MDA) director for advanced technology weapons, leading a small staff in support of kinetic- and directed-energy technology development for advanced ballistic missile defense systems. He led the air-launched hit-to-kill concept development and the MDA's evaluation of the Net-Centric Airborne Defense Element, a congressionally directed program to develop a new missile defense interceptor using an existing air-to-air missile seeker. Colonel Corbett joined the MDA in 2005 following his retirement from the Air Force. His military experience includes command positions at various levels within Air Combat Command and the Air National Guard, and over 5,000 hours in a variety of aircraft, predominantly fighters.

Let us know what you think! Leave a comment!

Distribution A: Approved for public release; distribution unlimited.

Disclaimer

The views and opinions expressed or implied in the *Journal* are those of the authors and should not be construed as carrying the official sanction of the Department of Defense, Air Force, Air Education and Training Command, Air University, or other agencies or departments of the US government.

This article may be reproduced in whole or in part without permission. If it is reproduced, the *Air and Space Power Journal* requests a courtesy line.

<http://www.airpower.au.af.mil>

Realizing Operational Planning and Assessment in the Twenty-First-Century Air Operations Center

How a Refined Planning Construct and Semantic Technologies Can Enable Delivery of the AOC's Last Unsupported Functions (Part 1)*

Wg Cdr Redvers T. Thompson, Royal Air Force, Retired



Operational planning and subsequent operational assessment are critical components of executing a modern military campaign and the supporting air operations.¹ Without future advancements, particularly in assessment, commanders will remain severely limited in their evaluations of whether their planned and executed actions have produced the desired effects. The variability of

*Part 2 will appear in the May–June 2013 issue of *Air and Space Power Journal*.

planning and assessment constructs and terminology, data sources, analysts' confidence, and the ability to readily understand and visualize operational schemes, plans, and evidence from the operational environment creates obstacles in campaign development and integration. The same is true of problems related to the access, collation, and analysis of related planning and assessment data. To address significant elements of these issues, this article proposes utilization of an evolutionary planning construct and abstract semantic data models of both operational plans and environments to relate and realign disparate data elements, thus enabling automated reasoning and inferencing across those models.

By way of recent example, for Operation Iraqi Freedom, US Air Forces Central planners had developed over many months a very detailed supporting joint air operations plan designed to attain air and space objectives. However, the assessment chain still had “weaknesses that might have resulted in significant fog and friction.”² Determining and identifying intended operational effects are critical to executing component strategies; during Iraqi Freedom the joint force air component commander (JFACC) needed to know the actual effects of his operations on Iraq's regime as well as on its ground and air forces. However, a lack of timely operational assessment limited his review and adjustment of the air strategy. Moreover, the inability to assess airpower effects also impinged upon the land component commander's maneuver decisions. The same dearth of assessment constrained the land commander's determination of strength and movement of Iraqi ground forces in front of his forces, an uncertainty that forced him to change his strategy to a much less efficient form of offensive maneuver: “maneuver to contact.”³

Although the above has focused explicitly on assessment, successful operations—like the proverbial three-legged stool—depend almost equally on three facets of the “control” aspects of command and control (C2) (i.e., planning, execution, and assessment). By necessity, each of these supports and enables in some way the other two—evi-

denced in many C2 research and development projects sponsored by the US Department of Defense (DOD). These projects have included problem statements regarding the necessity of “provid[ing] critical and actionable insight into planning and execution while supporting both co-located and distributed teams” through the application of “agile data integration.”⁴ Furthermore, these air-related C2 problems and capability shortfalls are symptomatic of capability gaps endemic across all US government operational domains. In addressing any problem areas in operational planning and operational assessment, therefore, one should extend the solution approach to or integrate it with all inter-agency, joint, coalition, and nongovernmental organizations’ domains.

Part 1 of this article establishes and analyzes the shortcomings of current operational planning and assessment methods. The remainder answers how many of those issues can be addressed through both the employment of the Comprehensive Adaptive Planning and Execution (CAPE) methodology and the utilization of semantic models of operational plans and their operational environments.

Problem Description: Command and Control—the Failing Domain

Poor Cross-Domain Operational Planning, Execution, and Assessment

The US Air Force has sought to address the fact that its air and space operations centers (AOC) are significantly deficient in their accession, visualization, or understanding of underlying data, systems, and impacts from ongoing operational planning, execution, and assessment. The AOCs’ processes and support tools do not adequately capture, convey, and display national strategic intent and objectives through both the joint force commander’s and JFACC’s operational-level plans to the latter’s detailed, day-to-day direction in his or her air operations directive.⁵ Finally, the multiple mission-specifics of the daily air tasking or-

der (ATO) must be executed through the “fog and friction” of combat operations while undergoing a continuous assessment and recommendation cycle. Not only do these deficiencies exist within a single component acting at a single level of war but also no current capabilities exist to capture and visualize operational plans and data—either horizontally across the various service, functional, and interagency domains or vertically through the various levels of war (i.e., national strategic, theater strategic, operational, and tactical).

As a contribution to the Project on National Security Reform’s study of the US government’s interagency process, a paper entitled *Choosing War: The Decision to Invade Iraq and Its Aftermath* noted that “the future is likely to present complex contingencies that will require significant capabilities in which the power of the entire government will be needed to make plans to solve multifaceted problems overseas.”⁶ In a related study on crisis planning, Dr. Williamson Murray, a Senior Fellow at the Institute of Defense Analysis and a member of the National Strategic Studies Group, points out that “no matter how impressive the conduct of . . . operations might be at the tactical level, there is no guarantee that linkages will exist to the strategic and operational levels without a considerable intellectual effort to think through the potential effects of policy decisions and strategy, or the possible contributions that tactical actions might make to the achieving of operational or strategic effects.”⁷

Against the backdrop of changes required across the entire US government and joint military community, the Air Force’s operational AOCs face the following issues:

- Providing a leading or contributory role in the operational design, campaign planning, and development of detailed supporting plans for operations to deter or defeat dynamic threats in multiple domains.
- Synchronizing air; space; cyber; and intelligence, surveillance, and reconnaissance (ISR) actions by time, space, and resource across

multicapable component elements and with other functional and service components and agencies.

- Dynamic assessment and replanning of ongoing operations to better inform decision makers and offer appropriate recommendations.

Problematic Integration, Coordination, and Visualization of Operational Plans and Knowledge of the Operational Environment

A particularly problematic area in the C2 domain involves the integration, coordination, and consequent visualization of information from strategic guidance, operational plans, ongoing combat operations, intelligence sources, and an ever-morphing operational environment. Many efforts over the past several years have made strides in creating user-defined operational pictures or common operational pictures.⁸ However, none have fully met requirements to supply a holistic view of the operational environment that is customizable and navigable by users at various levels of command who perform various functions.

A number of these problems were identified as factors that caused difficulties in assessing air operations during the initial phases of Iraqi Freedom. These included the format of mission report messages, which prevented rapid processing; incompatible joint and AOC information technology systems that hindered the effective sharing of assessment information; and a speed of campaign that served only to compound these and other problems. To address these issues, recommendations have included instituting systems that streamline the processing of mission reports and the enabling and promotion of the cross-domain use of common databases for information about targeting and battle damage assessment.⁹

Dislocated and Distributed Command and Control

As the Air Force continues to implement the organizational structure of the component numbered air force and distributed operations con-

cepts, it will forward-deploy fewer AOC functions. Therefore, both co-located and geographically separated teams will need workspaces that provide critical and actionable insight into an AOC's operations, generate both situational awareness and shared understanding, and synchronize collective air, space, cyber, C2, and ISR activities.

Further, the problems of dislocated and distributed C2 are not solely those of component numbered air forces and their AOCs; rather, they remain inherently ubiquitous across all operational DOD domains. The DOD has also determined that current C2 and planning paradigms are too slow and cumbersome, often resulting in plans that address conditions that no longer exist and that cannot adapt to the demands of today's dynamically changing security environment. Moreover, these paradigms offer no mechanisms to facilitate early and frequent consultation between military and civilian leadership regarding plan development and refinement.¹⁰

The multifaceted nature of current and future crises will demand that all of the US government's national instruments of power fight as a team, the logical extension of which is the need to plan, fight, and assess as a team. Commanders will adjust operations based on their assessment to ensure the realization of planned military objectives. Their assessment process must be continuous and directly tied to decisions throughout the planning, preparation, and execution of operations.¹¹ Consequently, C2 support tools should at least enable the effective integration of planning and assessment processes and data across all domains and levels of war, even if the innumerable idiosyncratic vagaries of discrete tactical elements prohibit cross-domain integration of tactical execution processes.

Lack of Visualization That Supports C2 Planning, Situational Awareness, and Decision Making

Currently, C2 tools range from a few custom applications to the familiar Microsoft Office and Post-it sticky notes. For the most part, the available information technology tools support very specific and dis-

crete C2 tasks. To the author's knowledge, no fielded C2 support tools explicitly relate tasked tactical missions with all of the following related data: (1) their associated operational and/or tactical objective(s), (2) entities in the operational environment with which the missions must directly interact (e.g., targets), and (3) entities on which one intends to produce any consequential effects. Additionally, because these basic data relationships aren't maintained, the shared understanding and visualization of those relationships have proved somewhat difficult to date.

One of the greatest limitations in today's conduct of the planning, execution, and assessment cycle is that teams performing one element of the cycle have limited insight into the decisions and products of prior elements. Information and decisions generated in prior cycle elements are not brought forward and presented in ways that effectively frame and support good decisions which maximize the attainment of larger strategy goals. For example, within the AOC, current systems do not maintain the linkage between the strategy or plan elements (e.g., operational and tactical objectives and tactical tasks), targets, and missions to aid in execution decisions and assessment. This significant deficiency in system/tool functionality is reflected by the necessary introduction into the AOC in recent years of additional personnel in the role of ATO coordinators (a.k.a. "football carriers"). These individuals ensure continuity and consistency from commander's intent through planning to action to assessment of each of the discrete—but multiple and overlapping—ATO cycles.¹²

As AOCs manage ever-increasing cross-domain operations, they will need support tools and visualizations that help planners apply separate and combined air, space, and cyberspace resources to meet a JFACC's operational objectives and understand their parts in the overall joint campaign. Knowledge of the progress towards those objectives and the shared understanding of their relevance and interactions within the campaign depend upon integrated and holistic AOC plan-

ning and assessment processes that can readily generate timely output that is easily and rapidly assimilated.

Solution Approach: Unifying and Visualizing Operational Plans and Environment through Dynamic Modeling

Unifying Cross-Domain Planning, Execution, and Assessment

To contend with the deficiencies in cross-domain operational planning, execution, and assessment, as discussed above, the DOD now recognizes the desirability of close integration and execution of any cross-government strategy that seeks to resolve any major crisis or conflict.¹³ This realization prompted a widely held belief in the need for a fully inclusive, comprehensive approach to the conduct of future national and coalition operations.¹⁴

The foremost and driving imperative of such an approach entails the determination and delivery of end-state conditions and their necessary intermediate, enabling, and/or contributory conditions within an operational environment. Two key elements of such a conditions-based approach to crisis and contingency planning, applicable in any operational domain, include a holistic understanding of the operational environment and emphasis on the required outputs of change in that environment.

Therefore, as a vital precursor to supplying commanders and staffs with tailored support tools and visualizations based on common operational understanding, one must first identify a construct or methodology capable of capturing the “unifying logic” of conditions-based operational plans. Moreover, the construct or methodology should also have comprehensive utility and meaning across all joint, interagency, coalition, and nongovernmental organization domains. CAPE is such a methodology.¹⁵ Only with the benefit of such a unifying, logical construct established and employed will it be possible to enable the effective coordination, adaptive planning, execution, and assessment of

complex, cross-domain, horizontally and vertically coordinated, full-spectrum operations—and visualization of the same.

CAPE: The Unifying Construct

Since clear strategic guidance is universally considered essential to the planning of operations, CAPE's construct utilizes, at its highest level, strategic end-state conditions that would collectively comprise the strategic end state. Although a defined military end-state represents the military's overall goal, other strategic end-state conditions will likely be associated with other national instruments of power. The military commander, having established the military end state, will identify the various constituent end-state conditions that will define the realization of all military objectives.

The author defines the concept of a line of effort (LOE), a key construct element within CAPE, as a logical line (representing a causal chain) that defines the orientation of actions, causal links, effects, objectives, and/or end-state conditions in sequence and purpose within an operational design.¹⁶ Further, the LOE is utilized as the main construct for logic-based visualizations. Figure 1 depicts a national strategic-level campaign visualization, displaying a number of notional strategic LOEs (diplomatic, military, economic, and information) delivering specific, individual strategic end-state conditions, along with a military end state comprising multiple, constituent military end-state conditions.

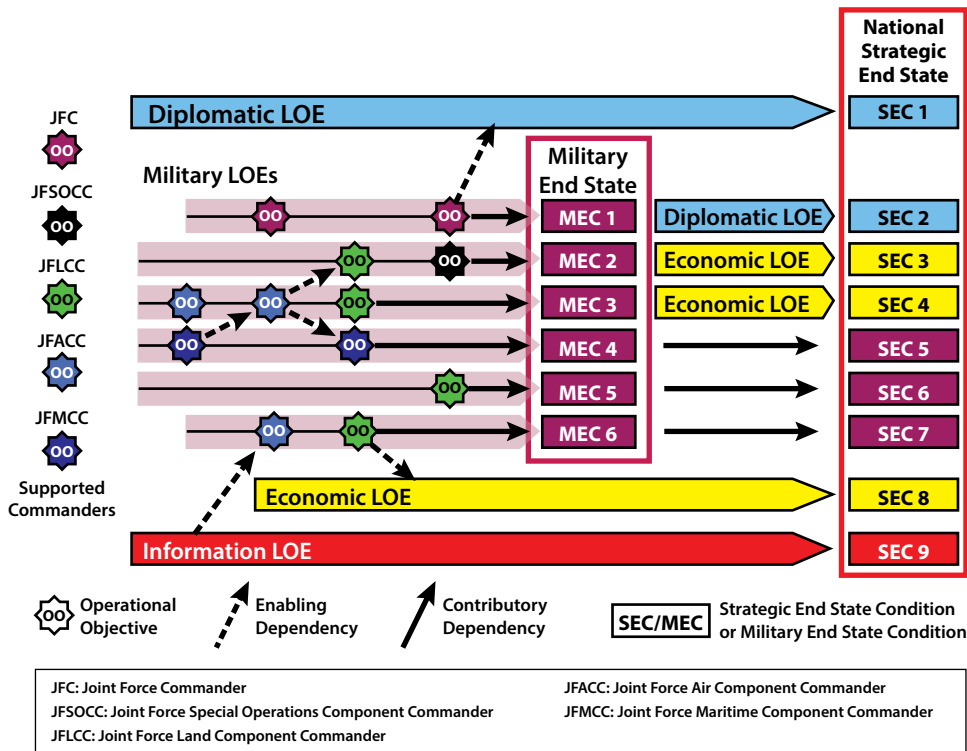

Figure 1. CAPE construct: Integrating military objectives with strategic lines of effort and operational objectives

A joint military campaign takes place primarily at the operational level of war; the production of sequenced and/or aggregated operational-level effects delivers the military end-state conditions. Within the CAPE construct, therefore, these intended operational-level effects become the operational objectives normally tasked to component/subordinate commanders. In essence, an operational objective is either an “enabling” milestone effect or final “contributory” effect required to reach a military end-state condition. One can develop and depict a military LOE, comprising sequenced operational objectives, for each mandatory military end-state condition. It is also possible to represent both established relationships or dependencies between a military LOE and other strategic LOEs and the assignment of responsi-

bility for an operational objective to a subordinate commander (in joint doctrine terms, the “supported commander” for that objective).

CAPE can depict all of this (see the center of figure 1, where stars represent operational objectives [OO] within each of the military LOEs and color coding represents their assignment to a joint force component). The figure introduces and illustrates only the strategic- and operational-level planning elements, but the CAPE construct has been developed down to the lowest level of tactical missions, actions, and targets (see the example discussed in the next section and illustrated in fig. 3).

The development of CAPE as an underpinning, logical planning methodology included the identification, classification, and definition of every planning element within its construct. Many of the planning elements (or terms) come from existing US military doctrine (e.g., Joint Publication [JP] 3-0, *Joint Operations*, and JP 5-0, *Joint Operation Planning*) and the author’s operational experience. Nevertheless, a continuing and extant problem within the C2 domain is that the vast majority of even the most widely used planning elements or terms, such as OO, tactical objective (TO), and tactical task (TT), have no formal definition or common schema for writing or applying them. Indeed, the author challenges this journal’s readership to find any authoritative (or otherwise) definitions of these three most commonly used planning terms. CAPE has rectified these specific definitional deficiencies by development of the following:

- Lexicon of CAPE planning terms and elements, including a formal definition of each term and element, based mainly on extant and evolving joint and service doctrine.¹⁷ It also includes many derived by the author.¹⁸
- CAPE planning element / syntax schema, which defines the structured syntax to be employed for the description and data capture of each category of CAPE planning elements.¹⁹ This formalized structure enables automated system extraction of the contextual and semantic detail contained within all of the individual ele-

ments of an operational plan; furthermore, it supports subsequent modeling of their relationships with other plan elements and the operational environment.

- Logical abstraction of CAPE planning terms and elements, which details the logical and semantic relationships among all the planning elements as they would exist within an operational plan.²⁰

Integration of Operational Knowledge through Dynamic Modeling

A unique methodology and technical solution makes possible the automated creation of dynamic, user-defined operational environment models (OEM). The latter offer multiple views of the operational environment through the integration of multiple sources of intelligence and operations data as well as ontological definitions of systems of interest. Just as a full, logical abstraction embraces all of CAPE's planning elements, so do multiple, similar abstractions include an exemplary range of entities that will exist in most operational environments (e.g., electricity power plants, power substations, airfields, air defense missile sites, hospitals, refugee camps, and petroleum distribution nodes).²¹

Upon these logical abstractions one can produce semantic OEMs and create visualizations. Figure 2 shows five entities (circles color-coded by political, military, economic, social, infrastructure, and information [PMESII] category) related by arrows that are color-coded by type of relationship link (logical, functional, physical, or behavioral).²² Four of those entities, identified as "targets," are linked to their respective constituent facilities or aiming points (the red triangles). These OEMs provide not simply a "snapshot in time" of friendly, neutral, and enemy systems. They offer an understanding of the relationships among systems and an indication of how friendly actions against specific targets affect these interrelated systems, enabling richer comprehension of current and evolving operational environments and threat domains.

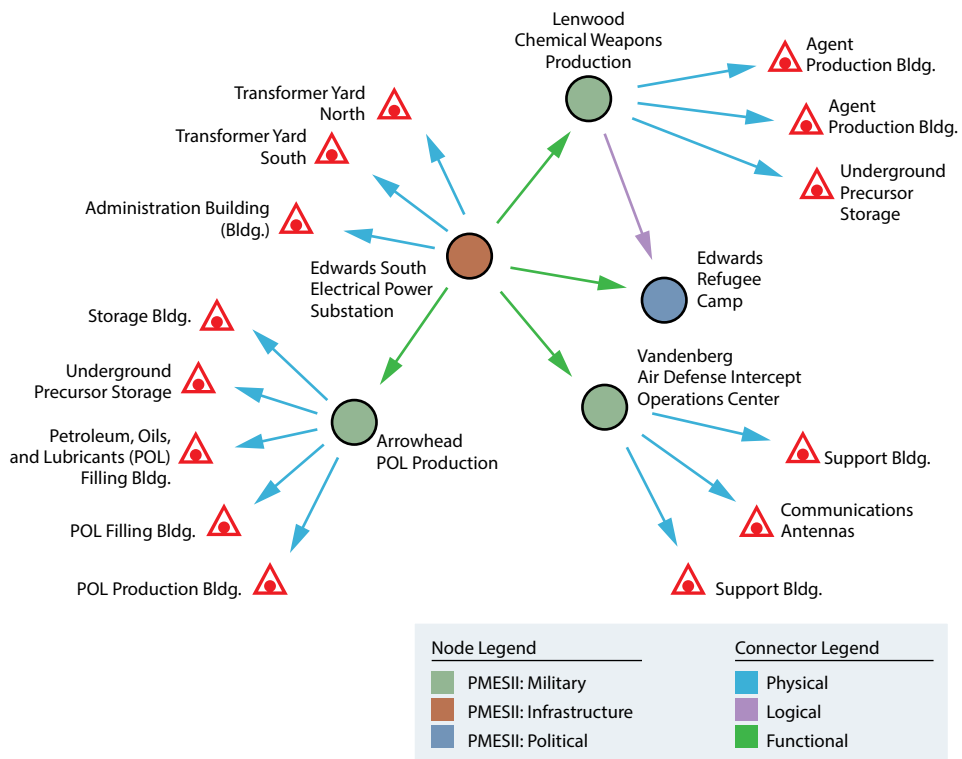

Figure 2. Logical representations of entities in an operational environment

In terms of the war fighter's and commander's understanding, such semantic data models, as exemplified by an OEM of an operational environment and its constituent enemy systems, can clearly (and to a significant degree) enable the much-sought ability to transform raw operational environment data into useful information, sound insights, and knowledge. Finally, they enable better decision making—a goal towards which the US government is currently making significant investments (more than \$200 million) under its Big Data Research and Development Initiative.²³ Beyond this broad operational utility of better decision support, these OEMs offer for the first time the potential to deliver the modeling of systems and systems of systems. The latter, in turn, can allow the automated support of nodal analysis and system-of-systems analysis—core concepts of effects-based targeting as articu-

lated and advocated widely within the Air Force and by Lt Gen David Deptula, USAF, retired, in particular.²⁴ They also allow the broader effects-based approach to military operations, as discussed and advocated in Air Force operational doctrine.²⁵

An extension of developing these dynamic, user-defined OEMs entails using the logical abstractions of the CAPE construct to develop a complete operational planning, execution, and assessment ontology that, with tool or system support, allows construction and maintenance of an operational plan model (OPM) “on the fly” as commanders and staffs plan, execute, and assess an operation. Key to the practical employment of these OPMs is that the logical construct establishes (for the first time) a standard method for capturing and visualizing plans. It also defines and captures all the semantic relationships among an operational environment’s constituent system elements and the various parts of a comprehensive, conditions-based plan.

Another key innovation—the identification within the CAPE construct of both *objects of action* and *objects of effect* as plan elements—plays a pivotal role in enabling this interconnection between an OPM and related OEM. An object of action denotes an operational environment element against which an action is planned or actually directed, whereas an object of effect is an operational environment element on which an effect is intended or actually produced. These key elements jointly act as one of two logical bridges or “touch points” between the two model types. That is, the plan model’s objects of action and objects of effect will also be discretely represented as operational environment system entities with the OEM, therefore enabling modeling interaction between the OPM and OEM.

The recognition, capture, and visualization of causal links—another key innovation of the CAPE approach—act as the second of the two logical bridges or touch points between OPMs and OEMs. These causal links constitute an identified mechanism that causes a given effect to be produced that is of a different nature to that of the contributory effect or action. The author considers it wise at this point to quickly ad-

dress the use of causal links within the CAPE construct, particularly the use of the phrase *identified mechanism*. To do so is appropriate, given the widely voiced criticisms of the effects-based approach to operations among elements of the US joint community, typified by statements such as “the ideas reflected in [effects-based operations] . . . have not delivered on their advertised benefits and . . . a clear understanding of these concepts has proven problematic and elusive for US and multinational personnel.”²⁶ The pertinent element concerns the meaning of *identified*. Its use here is not intended in the context of a “preknown” mechanism but in the context of either a recognized or acknowledged mechanism. That is, whether the mechanism is a pre-known fact or law of nature, something recently deduced from empirical observation or just a planner’s or commander’s best intuitive guess, it is the mechanism that has been identified (i.e., articulated and captured) as the assumed means of causing an intended effect. Perhaps one could ask the rhetorical question, What is the implication of an operational planning process that doesn’t identify the logical linkages between intended actions and required outcomes? To the author, the adage regarding hope as a poor foundation for a plan seems germane to any attempted answer.

Figure 3 offers a visualization of some of CAPE’s tactical-level planning elements, including the use of causal links. The figure depicts a tactical scheme for the delivery of the tactical objective “enemy Mechanized Infantry Brigade X unable to affect friendly ground assault.” The planners identified that Brigade X had to cross a local river to affect the friendly assault and that four key bridges spanned the river. Therefore, they devised a tactical scheme (LOE) that involved a single tactical task with a single ATO mission (Mission XYZ) tasked to drop (deliver functional kills on) the bridges with the direct effect that all of them would be unusable by mechanized infantry. Obviously, the planners assumed that this action would deliver an intermediate indirect effect of “Mechanized Infantry Brigade X unable to cross river”—the actual purpose of the TT (its objective). Then, as the third-order consequence, the planners believed that the intended TO would be delivered.

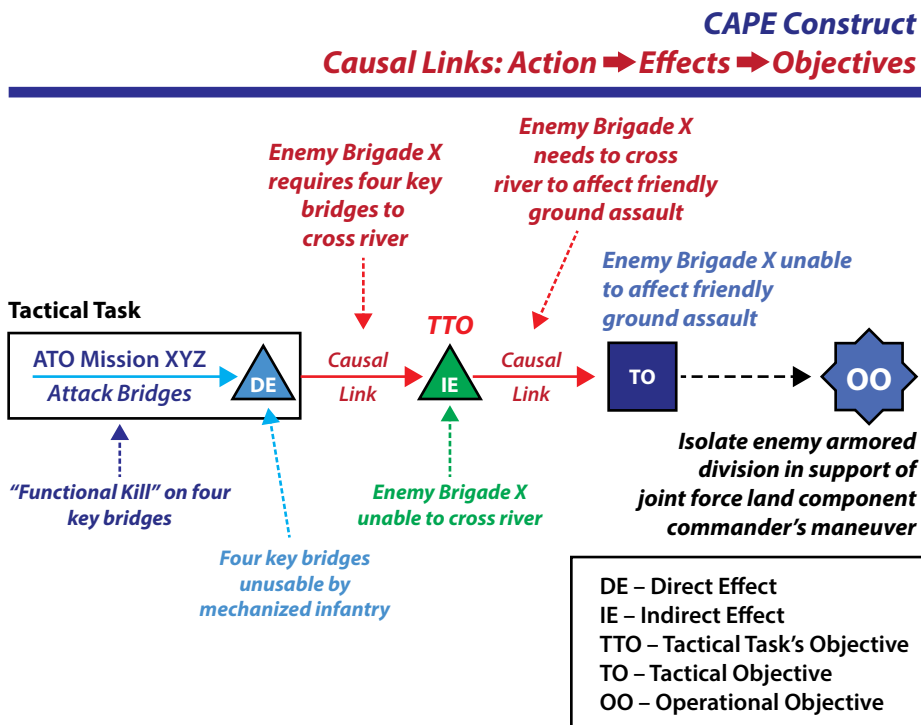

Figure 3. CAPE construct: Causal links within an operational plan

Therefore, in this example, the object of action was collectively the four key bridges, and the common object of effect (common to both second- and third-order effects) was the enemy's Mechanized Infantry Brigade X. However, one must note that the scheme sought to affect two different, specific capabilities of Brigade X: its ability to cross the river and its ability to affect the friendly assault. This is evidenced by the two discrete causal links that the planners assumed were in play: (1) enemy Brigade X requires four key bridges to cross the river and (2) to affect the friendly ground assault, enemy Brigade X must cross the river. Hopefully, the relevance of identifying and considering causal links is self-evident. As in the above example, if an assumed causal link proves false or not in play, the intended outcome or effect probably will not occur unless produced by some other unidentified

causal mechanism or fortuitous happenstance—but certainly not by the intended cause-and-effect scheme planned for.

The author again challenges this journal's readership to consider the implications of the above tactical scheme in terms of assumed causal links if any one or more of the following circumstances were actually in situ within the operational environment:

- The action followed a long period of drought and the river had been dry for many months.
- Brigade X was equipped with and well trained in the use of bridging equipment.
- Brigade X's order of battle had just been enhanced with a supporting long-range artillery unit.
- The actual maneuver of the friendly ground assault had to swing up against the friendly side of the river.

In most cases, the causal links employed within a plan are deduced during the various operational design, estimate, and planning processes, as illustrated in the above vignette. One can therefore see that within the CAPE approach, a causal link so identified and employed within an operational plan can be instantiated within the OPM. It should relate to some form of link (physical, functional, behavioral, or logical) that actually exists (planning fact) or that one assumes to exist (an identified planning assumption) between the relevant system entities in the operational environment (e.g., between the object of action and related object of effect). Therefore it can and should be captured and represented within the respective OEM. In other words, and as depicted in figure 4, one can directly relate a plan's/OPM's causal links to discrete (actual or assumed) system links in an OEM, as one can similarly relate objects of action and objects of effect to system entities in the OEM.

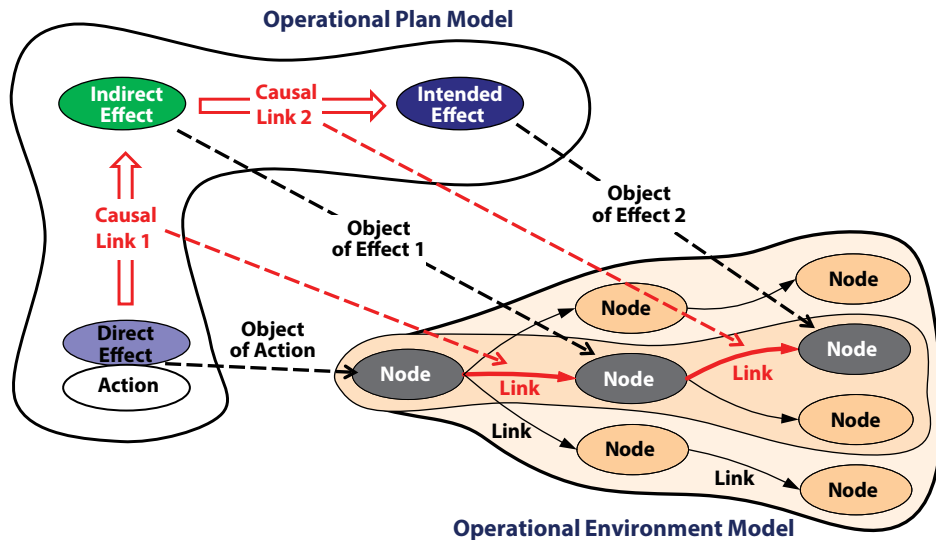

Figure 4. CAPE construct: Interconnections between OPMs and OEMs

As with the expansion above on the identification of causal links, it is worthwhile here also to expand on the introduction and use of the tactical task objective (TTO), a new planning element to those familiar with the Air Force's most common OO-TO-TT planning hierarchy. This evolution in terminology addresses both what is in fact the common (mis)usage of the term *tactical task* and the explicit identification and separation of tasked action from that of the action's desired effects. Specifically, CAPE defines a TT as a *discrete scheme of tactical action undertaken to produce an intended tactical-level direct effect* and a TTO as the *intended, discrete tactical-level effect that directly contributes to or enables the achievement of a tactical objective*.

In the author's AOC experience to date, TTs invariably have been written as intended tactical-level effects (equivalent to a CAPE-defined TTO); therefore, in CAPE terms, the current common usage already is OO-TO-TTO. CAPE is redefining the planning term *tactical task* to capture the tasks actually assigned to tactical units, as will eventually be represented in an ATO (or similar tasking order).²⁷ The tactical vignette offered above provides a clear example of this usage: the TT was the aircraft mission to deliver functional kills on four bridges, and

the TTO called for preventing Brigade X from crossing the river.²⁸ Indeed, one can recognize this construct simply as realizing within the Air Force's strategy-to-task construct the mission-type order, already ubiquitously employed within Army and joint communities (i.e., tactical unit X is tasked in an ATO to undertake TT Y in order to deliver TTO Z). In the author's operational experience both as a member of a strike/attack aircrew during Operation Desert Storm and as an operational planner/tasker during Operations Southern Watch, Allied Force, Enduring Freedom, and Iraqi Freedom, the ATO conveyed to a tasked unit only the required tactical mission (the required direct effect of the weapons). Very rarely, if ever, did it offer any insight regarding the "in order to" element—that is, the action's actual, immediate objective (the TTO), never mind the associated higher-order objectives (TO and OO).

The CAPE methodology also enables the ready incorporation of mission-type orders within the JFACC's normal tasking vehicle (the ATO) through the simple expedient of facilitating the referencing of the related TTO (and, arguably, the parent TO) within each ATO mission's tasking data/narrative. To emphasize the potential benefits of enabling the mission-type-order concept within the ATO, the author for the final time challenges this journal's readership to consider the following situations:

- In the above fictitious bridge-related vignette, during execution the tasked mission approaches the target area and sees mechanized infantry equipment streaming across the dry river bed south of the target bridges in what appears to be a more direct route to interdiction of the ongoing friendly ground assault. In one case, the mission lead is aware only of his ATO mission task of dropping four bridges; in a second case, the mission lead also knows about the mission's TTO of preventing a mechanized infantry brigade from crossing the river, which in turn is an order to prevent a mechanized infantry brigade from affecting the current friendly ground assault—the TO.

- In a second real-world vignette, which the author himself witnessed during Southern Watch, friendly forces tried desperately to locate a drone aircraft capable of delivering weapons of mass destruction (WMD) with which the Iraqis were playing a shell game among numerous hardened aircraft shelters (HAS). Out of the blue, ISR assets located the HAS housing the drone, so a strike mission launched with an ATO mission task of destroying HAS X. The mission returned, rightly boasting direct hits on the target HAS, and the crew added to the intelligence picture by reporting the sighting of a drone-like aircraft of interest sitting on the hard-standing across from the target HAS! Thus, as an alternate case to what actually occurred, the mission lead could have been made aware that the crew was tasked to destroy the HAS in order to destroy a WMD-capable drone aircraft believed to be housed in HAS X.

So both of the above situations raise the question, What would the likely variances in outcomes have been between the two cases (knowing or not knowing the “in order to”), and which would likely represent the more beneficial outcomes?

Conclusion to Part 1

Part 1 of this article has discussed the extant problems and failings of C2's operational planning and assessment capabilities across all of the US government's C2 domains and at all levels, which included ad hoc processes; a paucity of information-technology support tools; and limitations of data acquisition, correlation, analysis, and visualizations. It then examined how many of these shortfalls one could address through the employment of an evolutionary planning construct and methodology known as Comprehensive Adaptive Planning and Execution. The article went on to explain how the CAPE approach enables the utilization of abstract semantic models of both operational plans and operational environments to relate and realign data and to enable automated reasoning and inferencing across those models.

The second part of this article will describe how modern semantic technologies can efficiently implement—as services within a service-oriented architecture—the CAPE methodology, OPMs, and OEMs as a highly practical and effective planning and assessment paradigm for the twenty-first-century AOC. These services provide hitherto unavailable C2 resources and capabilities to commanders, planners, assessors, and analysts for timely decision making and achievement of campaign objectives. The second part will introduce the solution technology involved in the generation and integration of semantic planning and environment models and will discuss a proof-of-concept implementation. It will then show how the solution approach could benefit a comprehensive approach to planning, execution, and assessment, highlighting the solution benefits of this semantic, modeling-powered, CAPE-based approach to enabling unified and dynamic C2. ✪

Notes

1. This article is an abridged, amended, and updated version of the following: Redvers Thompson, Anton DeFrancesco, and Phil Warlick, “Enhancing Command and Control (C2) Assessment through Semantic Systems” (paper presented at the 16th International Command and Control Research and Technology Symposium, Québec City, Canada, 21–23 June 2011), http://www.dodccrp.org/events/16th_iccrts_2011/papers/135.pdf.

2. Lt Col David C. Hathaway, USAF, “Operational Assessment during Operation Iraqi Freedom: Assessment or Assumption?,” Air War College research paper (Maxwell AFB, AL: Air War College, 25 May 2005), 18.

3. Ibid., 15.

4. Air Force Electronic Systems Command, Small Business Innovation Research Topic AF093-025: “Visualization of Cross-Domain C2ISR Operations,” topic prerelease intent statement, July 2009.

5. Ibid., see “Description,” <http://www.afsbirsttr.com/TopicPreRelease/Profile.aspx?pk=20201>; and author's personal operational experiences from Operation Allied Force (Vicenza AOC, Strategy Division, April–June 1999), Operation Enduring Freedom (Headquarters US Central Command, J5, September–December 2001), and Operation Iraqi Freedom (Headquarters US Air Forces Central [CENTAF], Strategy Division, July–December 2002, and Prince Sultan Air Base–CENTAF AOC, Strategy Division, January–April 2003).

6. Joseph J. Collins, *Choosing War: The Decision to Invade Iraq and Its Aftermath*, Occasional Paper 5 (Washington, DC: National Defense University Press, April 2008), 28, <http://www.dtic.mil/cgi-bin/GetTRDoc?AD=ADA479692>.

7. Williamson Murray with LTC Kevin Woods, USA, *Thoughts on Effects-Based Operations, Strategy, and the Conduct of War* (Alexandria, VA: Institute for Defense Analyses, January 2004), 2, <http://www.dtic.mil/cgi-bin/GetTRDoc?AD=ada428069>.

8. Sandeep Mulgund and Seth Landsman, "User Defined Operational Pictures for Tailored Situation Awareness" (Bedford, MA: MITRE Corporation, 19 June 2007), http://www.dodccrp.org/events/12th_ICCRTS/CD/html/presentations/090.pdf.

9. Hathaway, "Operational Assessment," 19.

10. Deputy Under Secretary of Defense for Advanced Systems and Concepts (DUSD [AS&C]) PowerPoint Presentation, "Adaptive Planning Pilot (APP)–Joint Capability Technology Demonstration (JCTD)–FY08 Rolling Start," 21 December 2007; and DUSD (AS&C), "Adaptive Planning Roadmap II–2008," March 2008.

11. Joint Publication 3-0, *Joint Operations*, 11 August 2011, II-9, http://www.dtic.mil/doctrine/new_pubs/jp3_0.pdf.

12. Normally, each ATO is assigned a team of ATO coordinators. This two-person team acts as the primary focal point for its assigned ATO, ensuring continuity and consistency, preventing corruption of JFACC strategy and guidance, and resolving issues, as required, to produce that period's effects.

13. DUSD (AS&C), "Adaptive Planning Roadmap II–2008."

14. "A 'Comprehensive Approach' to Crisis Management," North Atlantic Treaty Organization, 21 March 2012, http://www.nato.int/cps/en/natolive/topics_51633.htm; and Marine Corps Combat Development Command, *Countering Irregular Threats: A Comprehensive Approach* (Quantico, VA: Marine Corps Combat Development Command, 14 June 2006), <http://www.fas.org/irp/doddir/usmc/irreg.pdf>.

15. The author developed the CAPE construct and employment methodology during the course of the planning and execution of Operation Iraqi Freedom, subsequently enhancing and detailing them during his remaining time as the Strategy Division chief, UK Joint Force Air Component Headquarters. He made further refinements during his exchange tour at the US Air Force's 505th Command and Control Wing, during which he was invited to introduce and instruct on the CAPE methodology as part of the Air Force's Command and Control Warrior Advanced Course.

16. This development and advocacy of LOEs predates the concept's recent parallel adoption within US Army planning doctrine: "A *line of effort* links multiple tasks and missions using the logic of purpose—cause and effect—to focus efforts toward establishing operational and strategic conditions" (emphasis in original). Field Manual 3-0, *Operations*, February 2008, 6-13, <http://downloads.army.mil/fm3-0/FM3-0.pdf>.

17. The lexicon draws from work undertaken by Headquarters Air Force Doctrine Center; the Effects-Based Operations Integrated Process Team; the Air Force Assessment Task Force; the 505th Command and Control Wing at Hurlburt Field, Florida; the Dynamic Air and Space Effects-Based Assessment Subject-Matter Expert Users Group; and Air University's College of Aerospace Doctrine, Research and Education, as well as some of the efforts conducted by US Joint Forces Command.

18. Thompson, DeFrancesco, and Warlick, "Enhancing Command and Control," Appendix B.

19. *Ibid.*, Appendix C.

20. *Ibid.*, Appendix D.

21. Ibid., Appendix E: Exemplar Logical Abstraction of Operational Environment Entities; Military Production and Distribution.

22. "Welcome to the PMESII Tool Index," US Joint Forces Command, 8 August 2008, http://pmesii.dm2research.com/wiki/index.php/Main_Page.

23. "Obama Administration Unveils 'Big Data' Initiative: Announces \$200 Million in New R&D Investments," news release (Washington, DC: Office of Science and Technology Policy, Executive Office of the President, 29 March 2012), http://www.whitehouse.gov/sites/default/files/microsites/ostp/big_data_press_release.pdf.

24. Brig Gen David A. Deptula, *Effects-Based Operations: Change in the Nature of Warfare* (Arlington, VA: Aerospace Education Foundation, 2001).

25. Air Force Doctrine Document 2, *Operations and Organization*, 3 April 2007, 13, <http://www.e-publishing.af.mil/shared/media/epubs/AFDD2.pdf>.

26. [Gen] James N. Mattis, "USJFCOM Commander's Guidance for Effects-Based Operations," *Parameters*, Autumn 2008, 19–20, <http://www.carlisle.army.mil/usawc/Parameters/Articles/08autumn/mattis.pdf>.

27. Although the author prefers to confine the main discussion here to the TT level and above, he wishes to preempt a question that may occur to some readers by noting that the term *tactical task* (TT) does relate to a discrete *scheme* of tactical action, which may be realized during tactical execution through one or more assigned ATO *mission tasks* (MT) (as determined during the targeting effects team [TET] and master air attack plan [MAAP] processes of the ATO cycle).

28. As discussed, normally the AOC's TET and MAAP processes determine whether in fact the TT is undertaken as a single mission (mission task), perhaps by a single bomber, or multiple missions (mission tasks), perhaps using multiple fighter missions and/or indirect fires from the land component commander's supporting assets (Army Tactical Missile System).



Wg Cdr Redvers T. Thompson, Royal Air Force, Retired

Wing Commander Thompson (MSc, Cranfield University; Royal Naval Staff College, Greenwich) is the senior military analyst for Securboron Incorporated, responsible for supporting the company with subject-matter expertise in military-science research and development as well as command and control (C2). A strike/attack navigator and instructor weapon systems officer, he served his final tour as an exchange officer in the post of deputy commander for development of the 505th Training Group, 505th Command and Control Wing. He was responsible for the development, integration, and standardization of the academic curriculum and training, with a particular focus on the development and advocacy of air strategy, operational design and planning, and the effects-based approach to operations. He has more than 12 years of experience in US, UK, and NATO C2, attaining operational experience on coalition operations, encompassing planning at the strategic, operational, and tactical levels. During three years as chief of the Strategy Division, UK Joint Force Air Component Headquarters, he served as a lead coalition planner at both joint force and component levels for US-led coalition efforts in Operations Allied Force, Enduring Freedom, and Iraqi Freedom. The chief of staff of the Air Force personally recognized Wing Commander Thompson's meritorious achievements in strategy planning in the Strategy Division of US Air Forces Central during Iraqi Freedom through his award of a Bronze Star in October 2007.

Let us know what you think! Leave a comment!

Distribution A: Approved for public release; distribution unlimited.

Disclaimer

The views and opinions expressed or implied in the *Journal* are those of the authors and should not be construed as carrying the official sanction of the Department of Defense, Air Force, Air Education and Training Command, Air University, or other agencies or departments of the US government.

This article may be reproduced in whole or in part without permission. If it is reproduced, the *Air and Space Power Journal* requests a courtesy line.

<http://www.airpower.au.af.mil>

Airmen and Mission Command

Lt Col James W. Harvard, USAF, Retired



Mission command is a hot topic that affects Airmen. In April 2012, Gen Martin E. Dempsey, chairman of the Joint Chiefs of Staff, published a white paper emphasizing the necessity of mission command and the importance of having all of the services and the joint force “ensur[e] that mission command is a common attribute of our Profession of Arms.” The paper also declares that “mission command must be institutionalized and operationalized into all aspects of the joint force—our doctrine, our education, our training, and our manpower and personnel processes. It must pervade the force and drive leader development, organizational design and inform material acquisitions.”¹

The chairman's guidance presents a challenge for Airmen because Air Force doctrine does not explicitly discuss mission command and because joint doctrine limits it to decentralized execution with mission-type orders. For the Airman, interpreting and applying this guidance

require an examination of the history, literature, and doctrine pertaining to mission command as well as an identification of where it and air doctrine intersect and diverge. More specifically, the Airman must understand the relationship between mission command and the Air Force doctrinal tenet of centralized control and decentralized execution.

The Origins of Mission Command: *Auftragstaktik*

Mission command has Prussian-German roots. In October 1806, Frederick the Great's Prussian Army suffered a defeat at the hands of Napoleon during the twin battles of Jena-Auerstädt, exposing Prussian failings and prompting reform—part of which included *directive command*. Under the latter, the commander of an army explained the general intent to his divisional commanders but left the details of each division's action to its commander. Directive command emerged from the belief that a commander of a large force could not control the action of subordinate units. It became firmly established in the Prussian Army but did not become official doctrine until Helmuth von Moltke's tenure as chief of the Prussian General Staff. At the time, conventional tacticians (*Normaltaktikers*) opposed directive command, wanting to issue explicit orders down to the last detail. These individuals coined *Auftragstaktik* (mission tactics) in the 1890s as a term of abuse for supporters of directive command because they considered it a threat to military discipline.²

Over time, the Prussians found that conducting operational-level maneuver warfare demanded a flexible system which enabled the initiative of lower-ranking commanders. *Auftragstaktik* provided this flexibility. The higher commander devised the general mission (*Auftrag*), leaving the means of accomplishment to the lower commander. Under Moltke, the Prussian Army prided itself on issuing general orders to subordinate commanders and then allowing them to devise the best way to carry out those orders. Throughout command echelons, orders were to be short, snappy, and to the point.³ *Auftragstaktik* flourished under Moltke, partly out of necessity. Slow communications and limitations of

the span of control rendered an operational environment where a decentralized approach to command and control (C2), or *Auftragstaktik*, proved more effective than a highly centralized command.

During War World II, Hitler became known for centralized command and interventions with his commanders. The advent of radio and the resultant speed of information exchange between lower-ranking commanders and the highest command echelons enabled Hitler's centralized style and a shift from decentralized to centralized command. Thus, credit for killing the concept of *Auftragstaktik* went to the radio—not Hitler.⁴ From World War II to current operations, each of our services has addressed centralized versus decentralized execution in its doctrine. An examination of these approaches is important to understanding and applying mission command.

The Marine Corps: Mission Command and Control

Marine Corps Doctrine Publication (MCDP) 6, *Command and Control*, presents two fundamental approaches for C2: (1) *detailed C2*, a centralized approach to execution, and (2), on the other end of the C2 spectrum, *mission C2*—the Corps's way of carrying out decentralized execution with mission-type orders.⁵ According to Marine Corps doctrine, detailed C2 derives from a belief that a powerful and highly efficient C2 system can impose order and certainty on the disorderly and uncertain operational environment.⁶ With this approach, C2 proceeds from the commander's personal direction or detailed directive. Largely centralized and formal, detailed command involves explicit orders or plans requiring strict adherence, effectively minimizing subordinate decision making and initiative. It utilizes a vertical path whereby information flows up the chain of command, and orders flow down. Characteristically, this centralized, detailed vertical approach tends to yield a C2 process that moves more slowly and may not react well to rapidly changing situations.

Conversely, mission C2 is decentralized, informal, and flexible. Rather than attempt to impose order on the disorderly, it reduces the level of the degree of certainty needed with centralized command by pushing decision authorities downward. By understanding the commander's intent, lower-echelon units can execute unencumbered by a structured, vertical decision process. Consistent with the intent of mission-type orders, Marine Corps orders and plans under the mission C2 approach are as brief and simple as possible, allowing subordinates maximum flexibility in decision making and therefore improving the ability to increase tempo and optimize effective responses to "fluid and disorderly situations."⁷

Marine Corps doctrine acknowledges that the employment of mission command or detailed command depends upon the situation and, in reality, may be a combination of the two. The Corps does, however, have a preferred approach founded upon its fundamental beliefs about the nature of war and the process of C2. MCDP 1, *Warfighting*, describes war as complex, driven by many variables. The execution of military action does not result from a single decision by a single entity but involves many independent and interrelated decisions by many individuals within a system. These decisions are shaped by human behavior and the complexities, inconsistencies, and peculiarities inherent in human nature.⁸ In other words, human behavior remains unpredictable; therefore, war is intrinsically unpredictable, making certainty in warfare impossible and yielding disorder. Reacting to disorder as situations change calls for continual improvisation. The effectiveness of devising and implementing improvisation depends upon the efficiency and effectiveness of C2 processes, which, according to the Marines, reside in the observe-orient-decide-act (OODA) model developed by the Air Force's Col John Boyd. Marine doctrine describes the OODA loop as the basic sequence for the C2 process.⁹ OODA is important to generating speed or tempo in that process in order to act inside the adversary's decision cycle. In light of Marine Corps beliefs about the nature of war, the service prefers mission C2, which it considers better suited to generating tempo in an operational environ-

ment characterized by the complexity, uncertainty, and disorder typical of the human dimension.

The Navy's Philosophy of Command and Control

Centralized planning and decentralized execution are the Navy's doctrinal tenet for command at the operational level and its C2 approach for operating at the required tempo. The service prefers decentralized execution for operating in the maritime domain, characterized by great distances and historically poor communications. Its decentralized approach to C2 is consistent with mission command. According to Navy Warfare Publication 3-32, *Maritime Operations at the Operational Level of War*, Navy operational commanders routinely have offered tactical forces direction and guidance through a clear statement of commander's intent and then rely on the initiative of their subordinate commanders to define "how" the action will occur.¹⁰

Even though the historical challenges of poor communications are largely mitigated by today's advanced information systems, the Navy still asserts the importance of decentralized execution. According to Naval Doctrine Publication 1, *Naval Warfare*, "Even in an era of nearly instantaneous communications . . . having the subordinate commander execute operations in accordance with a thorough understanding of the commander's intent is a key tenet of the naval forces' C2 philosophy."¹¹

Mission Command and the Army

The Army defines mission command as "the exercise of authority and direction by the commander using mission orders to enable disciplined initiative within the commander's intent to empower agile and adaptive leaders in the conduct of unified land operations."¹² Clearly, mission command in the Army involves much more than just decentralized execution with mission-type orders. Rather, in Army doctrine,

mission command reflects a philosophy of command and a war-fighting function. This concept includes the art of command and the science of control. Army Doctrine Publication (ADP) 6-0, *Mission Command*, defines the art of command as “the creative and skillful exercise of authority through timely decisionmaking and leadership.”¹³ As an art, command requires using judgment when making decisions—the commander’s responsibility. ADP 3-0, *Unified Land Operations*, observes that mission command, the war-fighting function, “develops and integrates those activities enabling a commander to balance the art of command and the science of control.”¹⁴ As a war-fighting function, mission command incorporates the science of control, which—outside Army doctrine—is C2. The science of control includes detailed systems and procedures to improve the commander’s understanding and to support the execution of missions.¹⁵ The mission command system includes personnel, processes and procedures, networks, facilities and equipment, and information systems—in other words, C2 to the other services and joint force.

The Army’s development of mission command into a construct with multiple meanings has created confusion. In fact the Combined Arms Doctrine Directorate supplied guidance to Army doctrine developers noting that “the Army term mission command replaced the term command and control. However, it is not exactly the same thing and not always a one-for-one replacement. Writers consider meaning and the part of speech (grammar) for correct usage.”¹⁶ Since the meaning of Army mission command can be confusing and vary with context, it is particularly important that Airmen read and seek to understand Army doctrine when working with that service and when considering the relationship of airpower doctrine to mission command.

Mission Command in Joint Operations

Joint doctrine provides a common approach to C2 by addressing fundamental principles applicable across the services. C2 is the first of six joint functions described in Joint Publication (JP) 3-0, *Joint Operations*,

as “related capabilities and activities grouped together to help JFCs [joint force commanders] integrate, synchronize, and direct joint operations.” Joint functions are common to all joint operations.¹⁷ For example, within the C2 joint function are tasks common to all of the services, which include, but are not limited to, organizing, commanding subordinate forces, planning, establishing appropriate command authorities, assigning tasks, allocating resources, coordinating, synchronizing, and—when appropriate—integrating.¹⁸

JP 3-0 describes mission command as “a key component of the C2 function.”¹⁹ Joint doctrine emphasizes the relationship of mission command to the commander’s intent, defining the former as “the conduct of military operations through decentralized execution based upon mission-type orders.”²⁰ When those orders accompany the authority for decentralized execution, subordinate commanders must clearly understand the superior commander’s intent, enabling subordinate leaders at all echelons to act independently with disciplined initiative to carry out the mission. This is the extent of mission command in joint doctrine.

Mission Command and Airpower

For the Airman, determining the path ahead necessitates understanding the relationship between mission command and the airpower tenet of centralized control and decentralized execution. Although airpower doctrine does not mention the term *mission command*, the latter’s philosophy and intent of fostering flexibility at the tactical level are inherent to air-mindedness.²¹ However, airpower’s uniqueness demands a tailored procedure distinct from the C2 of surface operations. Such an approach to the C2 of airpower is codified in the airpower tenet of centralized control and decentralized execution.

Joint doctrine and Air Force doctrine offer a consistent presentation of centralized control and decentralized execution. Both describe the former as giving one commander the responsibility and authority for planning, directing, and coordinating a military operation or group/

category of operations. Furthermore, both describe decentralized execution as the delegation of authority to subordinate commanders.²² The Air Force is consistent with joint and the other services' doctrine in advocating decentralization during execution. According to Air Force Doctrine Document (AFDD) 1, *Air Force Basic Doctrine, Organization, and Command*, "Execution should be decentralized within a command and control architecture that exploits the ability of front-line decision makers . . . to make on-scene decisions during complex, rapidly unfolding operations."²³

Air Force doctrine also recognizes that airpower's unique capabilities are best employed with a balanced approach between centralized control and decentralized execution, a tenet described in early airpower doctrine. In 1943, War Department Field Manual (FM) 100-20, *Command and Employment of Airpower*, codified this precept: "Control of available airpower must be centralized and command must be exercised through the Air Force commander if this inherent flexibility and ability to deliver a decisive blow are to be fully exploited."²⁴

Time has shown that good doctrine endures. From the July 1943 edition of FM 100-20 to the October 2011 edition of AFDD 1, airpower's immutable characteristics are still best employed with a proper balance of centralized control and decentralized execution. Based on these airpower characteristics, AFDD 1 explains the importance of centralized control.²⁵

Airpower has theater- or even global-ranging effects. Rather than having airpower operate only within a geographic area of operations, its inherent capabilities allow aircraft to quickly cross an entire joint operations area, theater, or theaters as required to meet the JFC's priorities. Consequently, an Airman who maintains the necessary broad, strategic perspective should centrally control airpower to ensure the allocation of limited resources to the highest-priority effort throughout planning and execution.

Airpower's theater- or global-ranging capabilities also give it the unique potential to create effects across the levels of war, from tactical

to strategic—again, a trait best suited for centralized control by an Airman, as experience has demonstrated.²⁶ AFDD 1 explains that some situations lend themselves to elevated levels of centralized control (e.g., the JFC or higher authority), particularly if airpower actions may produce strategic effects, such as the prosecution of high-value targets or the execution of a politically sensitive mission.²⁷

Typically, airpower assets remain in great demand and limited in supply. Shortfalls in satisfying requests for airpower, particularly those from the other services or functional components, require asset allocation based on the JFC's prioritization. Maintaining the flexibility to ensure the availability of airpower assets where and when needed depends upon a proper balance between centralized control and decentralized execution—again calling for a broad strategic perspective that permits movement from one objective to another, as demanded during planning and execution.²⁸

AFDD 6-0, *Command and Control*, speaks to a balance between too much and too little centralized control: “Overcontrolling air and space power robs it of flexibility, taking away initiative from operators. Undercontrolling air and space power fails to capitalize on joint force integration and orchestration, thus reducing its effectiveness.”²⁹ Optimizing flexibility is affected by this proportional relationship. In his paper *Centralized Control and Decentralized Execution*, Lt Col Clint Hinote claims that increased centralized control restricts flexibility at the tactical level while too much decentralized execution at the tactical level has the same effect at the operational level. He proposes the following important questions to assist in determining the proper balance.³⁰

What Is the Nature of the Operation?

The diversity of Air Force missions requires different C2 approaches. For example, space operations call for central control, which permits apportionment of high-demand, limited-supply assets to the highest priority at a strategic or operational level. Similarly, central control of nuclear operations gives the president more flexibility at those levels.

Close air support (CAS) missions, though, need a high degree of decentralized execution delegated through the theater air control system to joint terminal attack controllers in direct support of ground commanders. Decentralized execution at the tactical level for CAS or other missions, such as personnel recovery, provides the greatest flexibility and response to changing conditions.

Where Should Flexibility Be Preserved?

Determining where flexibility should be preserved combines considerations that include the nature of the mission and level of effects. For instance, we accept that decentralized execution maximizes tactical flexibility for CAS, but it is not an absolute since that mission is not limited to tactical-level effects. Against high-value or sensitive targets, CAS could yield operational- or strategic-level effects and therefore may warrant decisions made above the tactical level.

How Many Assets Are Available?

The need to centralize is proportional to asset availability and demand. High-demand, limited assets require enhanced levels of centralized control during planning and execution to ensure optimum allocation to the top priorities.

What Is the Geographical Range of Effects?

Hinote observes that centralized control over some assets with a constrained geographical range of effects, such as some rotary or remotely piloted systems, produces few benefits. However, it yields greater benefits for mobility and strike assets with their theater- and global-ranging effects because they can readily shift from one objective to another.³¹

Who Has the Best Situational Awareness?

Decision authorities should be delegated to the commander or operator with the best situational awareness, which may shift from the op-

erational to the tactical level during a mission. For example, aircraft performing on-call CAS may remain under centralized control until a situation develops in which airpower must support land operations. At this point, the joint terminal attack controller and aircrew will typically have the best situational awareness and should have the authority during execution to make decisions that maximize tactical flexibility. Scenarios marked by the optimization of situational awareness above the tactical level need a higher degree of centralized control. Execution decisions for time-sensitive, high-value targets, for instance, could be supported by analysis conducted above the tactical level—therefore driving the need for more centralization.

C2 capabilities and span of control are two other considerations important for determining the proper balance between centralized control and decentralized execution. We could generally characterize airpower operations in Iraq and Afghanistan as having a favorable span of control at the operational level—one enabled by a robust and uncontested C2 infrastructure. In the future, we may face adversaries in major contingency operations in which requirements for span of control exceed our C2 capabilities to centrally control or execute, thus driving a demand for decentralized execution. Additionally, future operational environments may prove less permissive. *The Joint Operating Environment 2010* describes future operational environments in terms of their complexity and uncertainty.³² The *Joint Operational Access Concept* describes antiaccess, area-denial trends that, combined with the operational environment anticipated in the *Joint Operating Environment 2010*, will present C2 challenges. These trends include (1) the dramatic improvement and proliferation of weapons and other technologies capable of denying access to or freedom of action within an operational area, (2) changes in the US overseas defense posture, and (3) the emergence of space and cyberspace as increasingly important and contested domains.³³ Given the effects of operating in an environment with degraded or denied space and cyberspace capabilities, either of which would likely degrade C2, then the question of balance between centralized control and decentralized execution quickly devolves to a

need for—not a choice of—decentralized execution, which also supports the rationale for the current mission command initiative.

The Airman's Response to Mission Command

For Airmen, understanding and effectively applying mission command begins with a solid foundation in airpower doctrine that will allow them to recognize the relationship between mission command and the airpower tenet of centralized control and decentralized execution. They should understand that the Air Force's preference for decentralized execution long antedates the recent initiative to implement mission command. In fact the mission command philosophy and its intent to foster flexibility at the tactical level are inherent to the airpower tenet of centralized control and decentralized execution. Airmen must also grasp that airpower capabilities are best employed with a balanced C2 approach that includes centralized control. Moreover, they should realize that balancing the appropriate degree of centralized control is not unique to the Air Force. The *Capstone Concept for Joint Operations: Joint Force 2020* acknowledges the requirement for centralized control: "It is important to note that while mission command is the preferred command philosophy, it is not appropriate to all situations. Certain specific activities require more detailed control, such as the employment of nuclear weapons or other national capabilities, air traffic control, or activities that are fundamentally about the efficient synchronization of resources."³⁴

Since *mission command* is a term in joint doctrine, Airmen have a responsibility to comprehend and apply it appropriately in a joint environment. They must fully understand that in joint doctrine, mission command is decentralized execution with mission-type orders and that C2 remains a joint function as described in JP 3-0.³⁵ Airmen should also know other services' approach to mission command and be able to engage other service members on this topic while clearly articulating Air Force doctrine. This ability is critical in a joint setting to ensure that the joint force appreciates the most effective applications of airpower.

Clear intersections exist among joint, Air Force, Navy, and Marine Corps doctrine regarding decentralized execution or mission command. Although all of the services advocate decentralized execution as the preferred approach to C2, the Army's approach to mission command and Air Force doctrine diverge significantly. As an overarching construct in Army doctrine, mission command implies the full spectrum of C2 options but does not adequately address detailed command and centralized control; neither does it recognize when these are appropriate and preferred. Therefore, Airmen must prepare themselves to articulate the appropriate application of centralized control for the reasons previously discussed. Regarding the philosophical intersections mentioned above, for example, the Army's principles of mission command—build cohesive teams through trust, create shared understanding, provide a clear commander's intent, exercise disciplined initiative, use mission orders, and accept prudent risk—are absolutely consistent with airpower doctrine.³⁶

Conclusion

All of the services and the joint force operate within environments characterized by the fundamental attributes of war, which include uncertainty and disorder. In these environments, we must generate the tempo described in General Dempsey's white paper on mission command as our ability to *operate at the speed of the problem*. Doing so will at times call for decisions made at speeds uncharacteristic of detailed or centrally controlled command systems; in other words, decentralized execution will be essential. However, we must also recognize that the C2 model for producing this tempo is not a one-size-fits-all proposition. According to the *Capstone Concept for Joint Operations*, "Each of the Services implement some version of mission command in the conduct of joint operations, but differences exist owing to characteristic missions and primary operating domains."³⁷ Each service shares common beliefs about the intrinsic value of decentralized execution and tailors its respective C2 approach to optimize the employment of its

unique capabilities within its domain. For the Airman, this means embracing the chairman's mission command philosophy while also promoting and maintaining the primacy of the airpower tenet of centralized control and decentralized execution. Airpower is still best employed with a balanced approach. ✪

Notes

1. Gen Martin E. Dempsey, *Mission Command White Paper* (Washington, DC: Joint Chiefs of Staff, 3 April 2012), 8, 6, <http://www.ndu.edu/pinnacle/docUploaded/MissionCommandPaper.pdf>.
2. Col R. R. Davis, "Helmuth von Moltke and the Prussian-German Development of a Decentralised Style of Command: Metz and Sedan, 1870," *Defence Studies* 5, no. 1 (March 2005): 84–85.
3. Robert M. Citino, *Death of the Wehrmacht: The German Campaigns of 1942* (Lawrence: University Press of Kansas, 2007), 4.
4. *Ibid.*, 305–6.
5. Marine Corps Doctrine Publication (MCDP) 6, *Command and Control*, 4 October 1996, 77–78, <http://www.fas.org/irp/doddir/usmc/mcdp6.pdf>.
6. *Ibid.*, 77.
7. *Ibid.*, 79.
8. MCDP 1, *Warfighting*, 20 June 1997, 14, <http://www.clausewitz.com/readings/mcdp1.pdf>.
9. MCDP 6, *Command and Control*, 63.
10. Navy Warfare Publication 3-32, *Maritime Operations at the Operational Level of War*, October 2008 (through change 1), 2-2.
11. Naval Doctrine Publication 1, *Naval Warfare*, March 2010, 36, [http://www.usnwc.edu/Academics/Maritime--Staff-Operators-Course/documents/NDP-1-Naval-Warfare-\(Mar-2010\)_Chapters2-3.aspx](http://www.usnwc.edu/Academics/Maritime--Staff-Operators-Course/documents/NDP-1-Naval-Warfare-(Mar-2010)_Chapters2-3.aspx).
12. Army Doctrine Publication (ADP) 6-0, *Mission Command*, 17 May 2012, 1, https://www.fas.org/irp/doddir/army/adp6_0.pdf.
13. *Ibid.*, 5.
14. ADP 3-0, *Unified Land Operations*, 10 October 2011, 13, http://usarmy.vo.llnwd.net/e2/rv5_downloads/info/references/ADP_3-0_ULO_Oct_2011_APD.pdf.
15. Army Doctrine Reference Publication 3-0, *Unified Land Operations*, 16 May 2012, 2-12, http://www.fas.org/irp/doddir/army/adrp3_0.pdf.
16. Combined Arms Doctrine Directorate Mission Command Center of Excellence, *Doctrine 2015 Developers' Guidance*, 4–12 (Fort Leavenworth, KS: US Army Combined Arms Center, 1 October 2012), 3, <https://www.milsuite.mil/book/docs/DOC-26286#comment-37380>.
17. Joint Publication (JP) 3-0, *Joint Operations*, 11 August 2011, III-I, http://www.dtic.mil/doctrine/new_pubs/jp3_0.pdf.
18. *Ibid.*, III-2.

19. Ibid., II-2.
20. JP 3-31, *Command and Control for Joint Land Operations*, 29 June 2010, IV-11, http://www.dtic.mil/doctrine/new_pubs/jp3_31.pdf.
21. Air Force doctrine describes air-mindedness as follows: "The perspective of Airmen is necessarily different; it reflects a unique appreciation of airpower's potential, as well as the threats and survival imperatives unique to Airmen. The study of airpower leads to a particular expertise and a distinctive point of view that General Henry H. 'Hap' Arnold termed 'air-mindedness.'" Air Force Doctrine Document (AFDD) 1, *Air Force Basic Doctrine, Organization, and Command*, 14 October 2011, 18, http://static.e-publishing.af.mil/production/1/af_cv/publication/afdd1/afdd1.pdf.
22. Joint doctrine defines centralized control as "placing within one commander the responsibility and authority for planning, directing, and coordinating a military operation or group/category of operations." JP 3-30, *Command and Control for Joint Air Operations*, 12 January 2010, GL-7, http://www.dtic.mil/doctrine/new_pubs/jp3_30.pdf. Air Force basic doctrine expands the definition of centralized control to "the planning, direction, prioritization, synchronization, integration, and deconfliction of air, space, and cyberspace capabilities to achieve the objectives of the joint force commander." AFDD 1, *Air Force Basic Doctrine*, 129. Decentralized execution is defined in JP 3-30 as "delegation of execution authority to subordinate commanders." JP 3-30, *Command and Control*, GL-8. AFDD 1 elaborates for clarification: "Decentralized execution of airpower is the delegation of execution authority to responsible and capable lower-level commanders to achieve effective span of control and to foster disciplined initiative, situational responsiveness, and tactical flexibility." AFDD 1, *Air Force Basic Doctrine*, 131.
23. AFDD 1, *Air Force Basic Doctrine*, 39.
24. Field Manual 100-20, *Command and Employment of Air Power*, 21 July 1943, 1, http://www.au.af.mil/au/awc/awcgate/documents/fm100-20_jul_1943.pdf.
25. For an expanded discussion on centralized control and decentralized execution, see AFDD 1, *Air Force Basic Doctrine*, chap. 4.
26. As part of the airpower tenet of flexibility and versatility, versatility is the ability to employ airpower effectively at the strategic, operational, and tactical levels of warfare. Ibid., 40.
27. Ibid., 39.
28. As part of the airpower tenet of flexibility and versatility, flexibility allows airpower to shift from one campaign objective to another, quickly and decisively. Ibid.
29. AFDD 6-0, *Command and Control*, 1 June 2007 (incorporating change 1, 28 July 2011), 13, http://static.e-publishing.af.mil/production/1/af_cv/publication/afdd6-0/afdd6-0.pdf.
30. Lt Col Clint Hinote, *Centralized Control and Decentralized Execution: A Catchphrase in Crisis?*, Research Paper 2009-1 (Maxwell AFB, AL: Air Force Research Institute, March 2009), 59–63, <http://www.dtic.mil/cgi-bin/GetTRDoc?AD=ADA550460&Location=U2&doc=GetTRDoc.pdf>.
31. Ibid., 61.
32. US Joint Forces Command, *The Joint Operating Environment 2010* (Suffolk, VA: US Joint Forces Command, 2010), http://www.jfcom.mil/newslink/storyarchive/2010/JOE_2010_o.pdf.
33. Department of Defense, *Joint Operational Access Concept (JOAC)*, version 1.0 (Washington, DC: Department of Defense, 17 January 2012), 8, http://www.defense.gov/pubs/pdfs/JOAC_Jan%202012_Signed.pdf.

34. Joint Chiefs of Staff, *Capstone Concept for Joint Operations: Joint Force 2020* (Washington, DC: Joint Chiefs of Staff, 10 September 2012), 5, http://www.defenseinnovationmarketplace.mil/resources/JV2020_Capstone.pdf.
35. JP 3-0, *Joint Operations*, III-2.
36. ADP 6-0, *Mission Command*, 2.
37. Joint Chiefs of Staff, *Capstone Concept*, 8.



Lt Col James W. Harvard, USAF, Retired

Lieutenant Colonel Harvard (BS, University of Georgia; MBA, City University, Seattle) is a doctrine development specialist at the Curtis E. LeMay Center for Doctrine Development and Education, Maxwell AFB, Alabama. He is also an adjunct faculty member at Air University's Air Command and Staff College where he teaches joint warfare in the Online Master's Degree Program and the Applied Joint Warfare course. He served in multiple positions at the squadron, wing, and major command levels in bomber operations, flight standardization/evaluation, developmental and operational flight test and evaluation, tactical air control party, and training and education. He has previously published in the *Air and Space Power Journal*. Lieutenant Colonel Harvard is a graduate of Air Command and Staff College and Air War College.

Let us know what you think! Leave a comment!

Distribution A: Approved for public release; distribution unlimited.

Disclaimer

The views and opinions expressed or implied in the *Journal* are those of the authors and should not be construed as carrying the official sanction of the Department of Defense, Air Force, Air Education and Training Command, Air University, or other agencies or departments of the US government.

This article may be reproduced in whole or in part without permission. If it is reproduced, the *Air and Space Power Journal* requests a courtesy line.

<http://www.airpower.au.af.mil>

Observations on the Air War in Syria

Lt Col S. Edward Boxx, USAF

His face was blackened, his clothes in tatters. He couldn't talk. He just pointed to the flames, still about four miles away, then whispered: "Aviones . . . bombas" (planes . . . bombs).

—Guernica survivor

Giulio Douhet, Hugh Trenchard, Billy Mitchell, and Henry “Hap” Arnold were some of the greatest airpower theorists in history. Their thoughts have unequivocally formed the basis of modern airpower.¹ However, their ideas concerning the most effective use of airpower were by no means uniform and congruent in their determination of what constituted a vital center with strategic effects. In fact the debate continues to this day, and one may draw on recent conflicts in the Middle East to make observations on the topic. Specifically, this article examines the actions of one of the world's largest air forces in a struggle against its own people—namely, the rebels of the Free Syrian Army (FSA).

As of early 2013, the current Syrian civil war has resulted in more than 60,000 deaths, 2.5 million internally displaced persons, and in excess of 600,000 refugees in Turkey, Jordan, Iraq, and Lebanon.² President Bashar al-Assad has maintained his position in part because of his ability to control the skies and strike opposition targets—including civilians.³ The tactics of the Al Quwwat al-Jawwiyah al Arabiya as-Souriya (Syrian air force) appear reminiscent of those in the Spanish Civil War, when bombers of the German Condor Legion struck the Basque market town of Guernica, Spain, on 26 April 1937. This purposeful bombing of a civilian populace shocked the world; Pablo Picasso later captured the incident in his famous mural *Guernica*.

Today the Syrian case invokes memories of Italian airpower theorist Giulio Douhet, who believed that aerial bombing could shatter civilian morale, unravel the social basis of resistance, and terrorize large portions of civilian populations.⁴ Although most modern Western militaries go to extraordinary lengths to perfect precision munitions and tactics designed to limit civilian casualties, early analysis reveals a much different approach in Syria. Indeed, the actions of the al-Assad regime will most likely be recorded as a bleak reminder of the abuses made possible and enacted by totalitarian regimes, reminiscent of principles predicted over a century ago by Douhet and others. Although a macabre narrative, the use of airpower in Syria demands examination, even while the fighting continues. This article, therefore, offers some observations on the past two years of civil war.

Evidently, the Syrian regime embraced Douhet's major premises and utilized airpower to target civilians first by means of helicopters and later fixed-wing aircraft, initially enabling al-Assad's forces to impede the FSA's advances and delay the regime's collapse. However the rebels have adapted to the threat, employing better tactics and more effective anti-aircraft weapons, and have since enjoyed a greater degree of tactical success. This analysis begins with a brief history of the rise of the al-Assad regime and then addresses the creation and buildup of the Syrian air force as well as events that led to the current conflict. It highlights several observations pointing to the conclusion that the regime embraced basic Douhetian theory as it executed an air campaign against rebel forces.

Background

Syrians celebrated Independence Day on 17 April 1946, “the date the last French soldier left Syrian soil.”⁵ The Syrian air force formed in 1948, not long after the United States had created its own air force. The embryonic 1950s-era service powerfully shaped future president Hafiz al-Assad—father of the current president—who consolidated power in Syria on 16 November 1970 and ruled until his death in 2000.

His personality and dictatorship were closely intertwined with the Syrian air force, and, in turn, he built it into one of the largest air arms in the Middle East.

As a former fighter pilot, squadron commander, air force commander, and defense minister, al-Assad embraced airpower, along with armor, artillery, and missile capabilities. In 1951 he was one of only 15 cadets chosen for flight training in Aleppo. He became an accomplished pilot, surviving multiple near-fatal incidents and even attempting to engage a British Canberra reconnaissance plane during the Suez crisis of 1956.⁶ Al-Assad was one of the few Syrian officers chosen to undergo MiG-15 and MiG-17 jet fighter training in the Soviet Union in 1958 and later led a fighter deployment to Egypt.⁷ The Syrian air force offered him an opportunity for social and intellectual advancement—especially important since he hailed from the oft-persecuted Alawite minority, comprising around 14 percent of the Syrian population and considered by some Muslims a heretical offshoot of Islam.⁸

As president, al-Assad installed members of his religious sect in key air force positions, a technique later replicated by his son. In the current conflict, Bashar al-Assad has adeptly convinced his fellow Alawites that their future is tied to his survival. As evidenced during the current civil war, a scenario involving a minority that perceives an existential struggle while it commands a large, modern air force can have disastrous consequences for civilians.

The Seeds of Dissent

We encountered a stoop-shouldered old man . . . who was shuffling along this field of death.

"Where are all the houses that once stood here?" we stopped and asked.

"You are driving on them," he said.

"But where are the people who used to live here?" I said.

"You are probably driving on some of them, too," he mumbled, and then continued to shuffle away.

—Thomas Friedman, *New York Times* correspondent
Hama, Syria, 1982

In 1982 a Sunni revolt led in part by the Syrian Muslim Brotherhood significantly challenged Hafiz al-Assad's rule. The regime's subsequent iron-fisted military response foreshadowed its devastating use of air-power today. The rebellion involved three of Syria's largest towns: Aleppo, Homs, and Hama, Sunni-majority communities that would later witness conflict opposing al-Assad during the civil war. Thomas Friedman's book *From Beirut to Jerusalem*, his seminal work on the Levant, assessed al-Assad's brutal crackdown on the Sunni uprising that may have killed almost as many Syrians, primarily in Hama, as the current civil war.⁹ Both then and now, one finds the tactics of destroying entire neighborhoods and historic landmarks and of killing non-combatants, not just to quell the uprising but to enact generational revenge. As a product of tribal politics, the Alawites' actions reflected a belief that cruelty was linked to their survival against the more populous Sunnis, justifying their devastatingly draconian counterrevolutionary techniques. Indeed, Hafiz al-Assad's authoritarian use of military might against civilians highlights the consequences of having a select group rule a military or an air force.¹⁰

Moreover, al-Assad interpreted some Syrians' desire for stability no matter the cost as tacit approval of his methods. Although one of the oldest continually populated areas in the world, Syria is a politically young country, and the regime exploited its nascent Baathist nationalism to accuse the Sunni rebels of dividing the country. Like his father, Bashar al-Assad now attempts to portray all of the armed opposition as outsiders, terrorists, and an existential threat to Syria.¹¹ Even some non-Alawites would prefer a stable government to an Islamic theocracy or a system marred by never-ending sectarian conflict, as experienced at times in neighboring Lebanon.¹² The many parallels with the

Hama massacre from decades earlier may help explain the Hobbesian tactics employed by the Syrian air force today.¹³

The Civil War

The current popular uprising, known as “the Day of Rage,” began on 15 March 2011 when protesters took to the streets around the country, responding in part to the detention earlier in the week of young men under the age of 15 who wrote that “the people want to overthrow the regime” on a wall in Deraa.¹⁴ By April the regime had adopted an aggressive approach, using tanks, infantry carriers, and artillery but no aircraft. The protests spread across Syria, but the two largest cities—Damascus and Aleppo (fig. 1)—remained unaffected initially. (Damascus, the seat of power, and Aleppo, the population center, are two of the longest continually inhabited places in the world.)¹⁵ But al-Assad’s forces soon sealed and stormed towns such as Deraa, in the south, and Latakia, in the west.¹⁶ In early June 2011, the northwest town of Jisr al-Shughour—a strategic crossroad between Aleppo and the Mediterranean coast on the historic Orontes River—witnessed the ambush of 120 Syrian troops, either by rebels and townspeople or by defecting Syrian troops.¹⁷



Figure 1. Major towns and lines of communications in civil-war Syria. (Reproduced by permission from the Institute for the Study of War, accessed 1 February 2013, <http://www.understandingwar.org/sites/default/files/ISWSyriaBaseMap%20copy.png>.)

According to Dr. Radwan Ziadeh, spokesman for the Syrian opposition, July 2011 marked the establishment of formal military resistance to the al-Assad regime.¹⁸ As the proficiency of Syria’s armed opposition increased, the Syrian military had to employ heavier weapons against the rebels. By January 2012, the regime had initiated large-scale artillery operations across Syria. In April of that year, al-Assad reacted to

unexpected FSA gains in Idlib and Aleppo by dispatching helicopters to engage “liberated” villages.¹⁹ Towards the end of May 2012, as the opposition mounted offensives, the regime began consistent use of helicopter gunships to compensate for its reduced mobility caused by the rebels’ effective interdiction of roads with bombs and ambushes. This elevated employment of helicopters culminated on 12 July during a massacre in the village of Tremseh. True to the major precepts of Douhet’s theories, helicopters bombed and *Shabiha* (Arabic for “ghosts”) irregulars stormed the town of 7,000.

In August 2012, the regime began to employ jet aircraft in an interdiction role as battle lines in Aleppo hardened and the regime’s helicopter usage peaked. Al-Assad may have ordered the use of fixed-wing platforms because of maintenance issues associated with operating approximately 50 helicopters and a lack of the highly capable Mi-25 Hind attack helicopters. The Mi-25 (the export version of the Russian Mi-24) was apparently reserved for important opposition areas—namely, Jabal al-Zawiya, a contested stretch of highway in Idlib, and the Rastan and Talbiseh areas of Homs. The Syrian air force’s employment of combat jets in bombing and strafing runs quickly overcame daily helicopter use in terms of sorties.

The rebels’ growing air-defense capability, which forced the regime to operate at higher altitudes, also accounts for the transition from rotary- to fixed-wing aircraft. The opposition responded to the regime’s air power by shooting down a limited number of aircraft and attacking air bases. By late summer 2012, the rebels’ equipment probably included 15–25 ZU-23s, two to five 57 mm towed air defense artillery guns (or others), and 15–30 SA-7 man-portable air defense systems (MANPADS).²⁰ Reports also indicated the presence of SA-16 and -24 surface-to-air missiles (SAM). The rebels primarily relied on heavy antiaircraft machine guns like the ZU-23 and, on at least one occasion, a MANPADS.²¹ As of October 2012, the FSA had shot down an estimated five rotary-wing and six fixed-wing aircraft, at least seven videos confirming the rebels’ success. Uncorroborated FSA footage shows shoot-downs of planes and heli-

copters and even captured fighter pilots and aircraft wreckage. Other reports place the number of aircraft kills higher, at 19; however, FSA videos and claims remain difficult to verify.²²

Additionally, the FSA initially sought to overrun regime air bases, including those at Abu ad Duhur (south of Aleppo), Minakh (north of Aleppo and home to more than 40 Mi-8 helicopters), Taftanaz (another helicopter base near Aleppo), and al-Qusayr (near Homs). Presumably, the rebels overran these air bases to take advantage of aircraft vulnerability on the ground or during takeoff and landing. Four of the successful aircraft engagements occurred near these military bases.²³

Throughout the conflict, the Syrian regime relied on heavy weapons (field artillery, mortars, and rockets) as the primary means of quelling the rebellion. Later it increasingly employed airpower to slow the FSA advance, as evidenced in late October during the proposed cease-fire for the Muslim holiday Eid al-Adha. Rather than diminishing, the regime's air attacks actually spiked significantly, from an average of 20–25 air strikes per day to over 60 on 29 October alone. In that month, the fighting between the FSA and al-Assad's forces reached a crescendo with a tally of 764 reported clashes—the most since the war began.²⁴ Regardless of the reason for the change, the accelerated use of airpower indicated a waning ground offensive by regime forces.

Targeting Civilians?

By September 2012, many international observers believed that the Syrian air force was targeting civilians, primarily employing its aircraft in a punitive and retaliatory manner rather than a tactical one.²⁵ Empirical evidence and observations in one of the world's most videoed civil wars indicate that a majority of the regime's air strikes have targeted towns and neighborhoods where the rebels had gained control, rather than specific rebel military sites.²⁶ The 13-plus aerial bombings that occurred as Syrian civilians stood in line at bakeries and communal olive presses during harvest time illustrate their vulnerability to

airborne attacks.²⁷ By October 2012, it had become apparent that the Syrian air force made no pretense of avoiding civilian deaths when it attacked towns containing rebel forces (fig. 2).²⁸

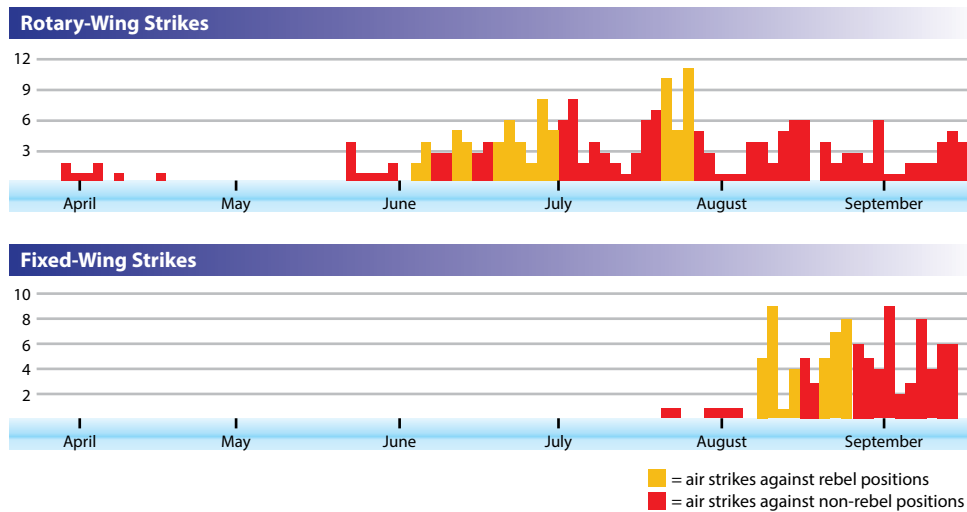

Figure 2. Air strikes against the FSA, 1 April–1 October 2012. (Reproduced by permission from Joseph Holliday and Christopher Harmer, *Syrian Air Force and Defense Overview* [Washington, DC: Institute for the Study of War, 25 October 2012], 4, <http://www.understandingwar.org/press-media/graphsandstat/syrian-air-force-air-defense-overview>.)

Furthermore, the regime has used its Mi-8/17 helicopters to toss old storage tanks or sheet metal cylinders packed with explosives and metal scrap—“barrel bombs”—out of helicopters. No one knows whether the air force used this tactic to maximize its helicopters’ multifunctionality or to save factory-grade munitions for the attack jets. Regardless, high-altitude employment of these “bombs” clearly terrorized the civilian populace to great effect. One Syrian refugee described the bombs as so big that “they sucked in the air and everything crashes down, even four-story buildings.”²⁹

The Syrian Air Force

By late summer 2012, the regime likely had no more than 200 combat-capable aircraft—approximately 150 jets and 50 helicopters—of the 600 in its total pre-civil-war inventory, and even those had varying degrees of combat capability. Additionally, in light of historical maintenance shortcomings, combined with the pace of operations, the al-Assad regime probably can employ no more than 30 to 50 percent of its aircraft.³⁰ The air force may have reserved its higher-end MiG-25s, -29s, and Su-24s in preparation for external intervention—but it may also have been unable to use these air-to-air designs in air-to-ground roles. For instance, the MiG-25—known as a “flying ironing board” because of its use in high-altitude intercepts rather than low-level maneuvering—is certainly not suited for an air-to-ground role. The Syrian leadership may also be concerned about further desertions. A Syrian MiG-21 pilot made a much-publicized defection to Jordan in June 2012; moreover, reports from inside the air force reveal that non-Alawite pilots must stay in the barracks and that only “vetted” Alawite pilots may fly, indicating that more fighter pilots could defect if given the chance.³¹

Like many modern air forces, Syria’s was not prepared to fight an insurgency, having focused primarily on a potential Israeli threat, which explains the re-role of L-39 (Albatross) aircraft not as trainers (their primary purpose) but as close air support platforms. The surprising use of L-39s may have resulted from the fact that they have fewer maintenance problems than the more finicky MiG jets, their comparatively better performance at lower altitudes and airspeed, or simply the presence of more pilots proficient and comfortable with a trainer aircraft.

In January 2012, the Syrian air force attempted to buy 40 Yak-130 trainers from Russia, but in July 2012, under pressure from Washington and the United Nations, Russia did not deliver the promised planes.³² This interest in these advanced fighter-trainers corresponded with the heightened use of the L-39 trainers, likely reflecting the regime’s wish to employ more ground-attack aircraft. At the end of No-

vember 2012, Su-17 and Su-22 Fitters made their first appearance in the war. Experts believe that a surge maintenance effort and large inventory allowed the regime to make a few of these aircraft flyable and thus introduce them into the conflict.³³

Syrian Air Defenses

Syria's air defense network at the start of the civil war ranked among the most capable and dense in the world, perhaps second only to North Korea's and Russia's. These multilayered defenses and the threat of Scud-launched chemical weapons were two major concerns during the interagency debate over a US-led no-fly zone. Located primarily along the Damascus-Homs-Aleppo corridor (see fig. 1) and the Mediterranean coast, the overlapping coverage of missiles and radars consisted of approximately 650 static air defense sites, the most worrisome of which housed the SA-5 "Gammon," having a range of 165 nautical miles and an altitude capability of 100,000 feet. Syrian platforms also included more than 300 mobile air-defense systems, the most capable of which included the newer SA-11s and SA-17s as well as the antistealth and anti-cruise-missile SA-22s. The downing of a Turkish F-4E fighter near Latakia on 22 June—although the cause of the crash remains unknown—enhanced the perceived lethality of al-Assad's air defense system.

On the other hand, Syria's Russian-made air defense legacy systems had limitations. A Syria-bound Russian jet diverted by Turkey reportedly carried much-needed spare parts. Also, the North Atlantic Treaty Organization and the Israeli air force have repeatedly and effectively penetrated and suppressed Russian-made systems. Indeed, the internal conflict has significantly degraded the effectiveness of Syria's air defenses. As with the ground forces, absenteeism and defections have plagued the readiness of Syrian missile and radar systems. In the past year, the FSA has captured SA-2 and SA-8 launchers and overrun SA-2, SA-3, and SA-5 sites and facilities.³⁴ Towards the end of October 2012, as the rebels consolidated gains in the north in Idlib province, Syrian

forces had to destroy some of their SAMs to prevent them from falling into FSA hands.³⁵ By December 2012, FSA battalions stationed in the governorate of Damascus had “gained control of most of the air defense bases in the governorate.”³⁶

Advantage Rebels

We control 70 percent of the sky, because if you compare the situation now to two months ago there are a lot less airplanes.

—Khelif Abu Allah, a Dushka gunner
November 2012

In late November and early December 2012, the Syrian opposition gained momentum. The war had been nearing a stalemate when rebel forces suddenly overran multiple air bases, including Marj al-Sultan outside Damascus, several major ground installations, and the Tishreen hydroelectric dam near the Turkish border. Rebel gains in the far-flung eastern province of Deir al-Zour led to government withdrawal from its last bases in Deir al-Zour City (Syria’s sixth-largest city), leaving rebels in control of the Syrian oil fields. Rebel forces exerted increasing pressure on Damascus itself, including the country’s international airport.

These successful engagements illustrate the rebel fighters’ new, effective strategy. First, as a way of impeding airpower, they focused on seizing the bases responsible for launching the bombardments and air raids. The rebels shifted away from trying to capture and hold territory inside villages and towns because Syrian aircraft would simply return and bomb the newly gained area and its civilian populace. Unlike before, the rebels quickly dispersed to avoid becoming massed targets for counterattacking aircraft. The change in tactics also constituted an attempt to regain waning public support: rebels and civilians alike realized that captured territory—especially urban settings with little or no military value—invited a devastating regime air assault.³⁷ Holding on to such ar-

eas proved too costly, alienating civilians who bore the brunt of the airborne counterassault—exactly the intent of the Syrian regime (i.e., show the population that supporting the rebels left civilians exposed).

Second, the rebels used the air bases as vital supply depots for obtaining heavy weapons and anti-aircraft weapons, thus creating an ad hoc, low-altitude, layered defense through machine guns and MANPADS. The FSA acquired additional shoulder-fired missile systems, as many as 40, during the renewed fall offensives and shot down two helicopters and a fighter jet in Aleppo province the first week of December.³⁸ A video of one of the attacks posted online shows what appears to be a SAM slamming into a helicopter.³⁹ In another video, a Syrian Dushka machine gun mounted atop a small truck waits with a dismounted rebel MANPADS squad on a remote mountain, forming a machine gun, infrared-rocket air defense team. In the cities, footage shows Dushka-mounted trucks speeding towards aircraft sightings as an improvised quick-reaction air defense team. By the first week in December, at least one rebel truck was armed with not only machine guns but also a MANPADS—an improvised “all purpose” mobile air defense artillery vehicle. Further, video shows rebels using camouflage (cut tree limbs and brush) and firing from concealed positions in orchards and among buildings. In January 2013, an FSA convoy conducted an extensive “pass in review” near Aleppo with varying degrees of heavy weaponry mounted on or towed by civilian and captured military vehicles.⁴⁰

In particular the march towards the Damascus airport carries significant psychological and strategic importance, demonstrating that al-Assad's seat of power is in jeopardy.⁴¹ The rebels' pressure on airport operations caused both Emirates Airline and Egypt Air to temporarily cancel flights to the Syrian capital and disrupted replenishment of the regime's arms from Iran and Russia. The duress that they exerted on the Damascus airport, which hosts Syria's military transport and VIP aircraft, bolstered December reports of al-Assad losing hope of escaping his country.⁴² Indeed, the Obama administration considered

“deeper intervention to help push President Bashar al-Assad from power.”⁴³ Not more than a week later, Washington officially recognized the new National Coalition for Syrian Revolutionary and Opposition Forces as the legitimate political authority in Syria. In January 2013, due to increasing rebel checkpoints and fear of being engaged by SAMs on takeoff, over 80 Russian evacuees traveled by bus to the Beirut airport in Lebanon instead of departing from the international airport in Damascus.⁴⁴

As discussed earlier, Syrian air attacks continued to increase after the failed Eid al-Adha cease-fire. At the same time, the rebels claimed to have destroyed a grand total of 111 Syrian aircraft, half of them airborne kills and the others destroyed while sitting on the tarmac.⁴⁵ On 12 December, the regime launched its first Scud missile from Damascus against rebel positions in Aleppo, perhaps signaling that the Syrian civil war has reached another milestone—this time from airpower to surface-to-surface theater missiles as the FSA wears down the Syrian air force. To date, the Syrian regime has launched more than 25 Scuds and “Scud-like” missiles at targets in northern Syria and the Damascus suburbs.⁴⁶ Syria’s winter weather certainly has adversely affected the regime’s air force operations, but the use of missiles may suggest the strain on the Syrian air force along with the need to deliver ever-increasing munitions against the advancing rebels and the willingness to use every available weapon in the regime’s arsenal.

The FSA further demonstrated its ability to maintain an offensive in January 2013 when the rebels scored their most significant military victory to date—the capture of the strategic Taftanaz Air Base in northern Syria. Mentioned earlier, this base near Aleppo had been under siege for months. The FSA was “able to concentrate adequate forces, coordinate their actions, bring heavy weapons to bear, and sustain the siege for months under regime air attack.”⁴⁷ Besides the destruction of 20 of the Syrian air force’s helicopters and the capture of large amounts of weaponry and ammunition, this accomplishment demonstrated the rebels’ capacity to siege and capture heavily defended air bases.

Conclusion

The spread of protests across the Middle East has been labeled an *Arab Spring*, but perhaps the term *intifada* better describes the events in war-torn Syria.⁴⁸ Thus far, the civil war has embodied neither a new beginning nor a new growth; *intifada*, which means “throwing off a yoke,” seems more indicative of this antiregime struggle.

Although the Syrian *intifada* continues, some tentative conclusions present themselves. Throughout the war, the Syrian regime has attempted to thwart the rebels with its heavy ground weapons systems, and since the summer, airpower has played a crucial role. Syrian aircraft bombed populated areas and opposition forces, causing thousands of civilian deaths and thus enabling the al-Assad regime to maintain a degree of psychological dominance. In multiple discussions, visits with Syrian opposition leaders and rebels, and trips to the region, the emotionally charged topic of aircraft bombings dominates conversations.⁴⁹ Bashar al-Assad's regime will one day become associated with the use of airpower against a civilian populace. Although it used artillery in greater numbers than aircraft, Syrians consider helicopters and fighter aircraft the visceral means of death and destruction. Therefore, the Syrian struggle will be remembered as another dark chapter in the record of conflicts such as the Spanish Civil War and Saddam Hussein's bombing of Iraqis and Kurds.

No one knows whether the incremental use of airpower was a purposeful regime tactic or simply arose out of a need for flexible delivery of munitions. The regime may have resisted using aircraft because it feared Western intervention in the form of a no-fly zone. Presumably, early use of aircraft against civilians would have garnered too much international attention, a lesson most likely learned from the conflicts in Iraq, Bosnia, and Libya. Whereas a gradual approach to aerial bombardment made intervention by outside powers less likely, Syria's robust air defense systems, surface-to-surface missiles, and larger chemical weapons inventory influenced US policy makers and military

planners—a fact not unnoticed by other totalitarian regimes such as North Korea and Iran.

Al-Assad's airpower, however reduced, retains a capability to strike anywhere in Syria at a time of its choosing. Even a limited ability remains a powerful tool of the regime to influence Syrians psychologically as well as physically. Nevertheless, the FSA's newly adopted hit-and-run tactics have enabled it to make substantial gains in spite of a relentless, Douhetian-style air campaign. The rebels eventually implemented a two-pronged strategy by raiding the regime's air bases and cobbling together a low-altitude air defense network, thus preventing a quick victory as predicted by Douhet. Both the Syrian regime and the FSA have adapted over the past two years. The Syrian air force confronted an unexpected counterinsurgency, while the rebels slowly formed an ad hoc yet effective air defense system that, combined with ground advances, may eventually blunt the effectiveness of al-Assad's aircraft and surface missiles.

It remains to be seen whether the al-Assad regime will suddenly collapse or slowly contract into an "Alawite rump state" with the FSA gains. Undoubtedly, airpower has allowed the regime to stay in power, but battlefield losses and problems with aircraft maintainability have severely crippled one of the largest air forces and missile defense systems in the Middle East. The Syrian air force, crushed by Israel in 1967 and 1973, recovered after each defeat with more sophisticated weaponry, but it is hard to imagine a similar revival after this war has ended. Given the current toll of death and destruction, a drying up of oil reserves, and a burgeoning population (with high unemployment), one doubts whether that air force (historically an anti-US organization) would threaten either America or its regional partners. The fallout of the civil war in Syria will create a myriad of future security issues for the United States, but they will differ from the pre-2011 model of Soviet fighter squadrons and integrated air defenses led by a single autocratic leader.

The lack of direct US involvement in the conflict justifies further exploration. As the death toll rises, as anti-US Islamic groups gain influence, and as one considers the prospect of a lack of control over chemical weapons in a post-Assad Syria, airpower experts will justifiably discuss what the United States could have done, either through no-fly zones, air strikes, or assistance with heavier weapons. A combination of the death of more than 60,000 civilians, the displacement of millions, and the “any moment” threat of chemical weapons raises the future “intervention bar” of the US Air Force to new heights. In light of the past two decades of airpower rescues in Iraq, Bosnia, and Libya, the role of Western air forces in protecting Muslim civilian populations from despotic rulers has evidently ended. Thus, the pre-Syria Libya operation may become a footnote in history—the last example of a no-fly zone enforced by the US Air Force.

Other viewpoints and lessons learned will most surely surface as more information becomes available and validated. The Syrian conflict is certainly too broad and complex to lend itself to coverage in a single article, but this one has sought to document and discuss airpower themes through a historical framework of the civil war. The words of Douhet and others who predicted widespread terror and fear from the air ring surprisingly true a century later. Picasso's *Guernica*—over 100 years old and inspired by a different war, location, and time—still represents the loss of human life and physical destruction in today's Syria. Homs, Hama, Aleppo, and other Syrian towns and villages are linked to Guernica through a shared narrative—airpower used for a dark and singular purpose. ✪

Notes

1. Jeffrey White, Defense Fellow at the Washington Institute for Near East Policy, and Katie Kiraly, research assistant for the Program on Arab Politics, contributed to this article.
2. Megan Price, Jeff Klingner, and Patrick Ball, *Preliminary Statistical Analysis of Documentation of Killings in the Syrian Arab Republic* (Palo Alto, CA: Benetech, 2 January 2013),

1–4, <http://www.ohchr.org/Documents/Countries/SY/PreliminaryStatAnalysisKillingsInSyria.pdf>.

3. “Measured Approach to the Syrian Crisis,” editorial, *New York Times*, 30 November 2012, <http://www.nytimes.com/2012/12/01/opinion/a-measured-approach-to-the-syrian-crisis.html>.

4. Robert S. Dudley, “Douhet,” *Air Force Magazine* 94, no. 4 (April 2011): 64–67, <http://www.airforce-magazine.com/MagazineArchive/Documents/2011/April%202011/0411douhet.pdf>.

5. Eyal Zisser, *Asad's Legacy: Syria in Transition* (New York: New York University Press, 2001), 1.

6. Patrick Seale with the assistance of Maureen McConville, *Asad of Syria: The Struggle for the Middle East* (London: I. B. Taurus, 1988), 52. Seale is Hafiz al-Assad's biographer. A phone call from Iraq notified the Syrians that the British surveillance plane was inbound from Iraq as it departed for Cyprus; “Asad had the satisfaction of firing his cannon at it” (ibid.).

7. Ibid., 279.

8. Central Intelligence Agency, “Syria,” *The World FactBook*, 22 January 2013, <https://www.cia.gov/library/publications/the-world-factbook/geos/sy.html>.

9. Supposedly, during an interview, Rifaat al-Assad, Hafiz al-Assad's brother and the regime's on-scene commander in Hama, disputed the reported number of 7,000 killed: “What are you talking about, 7,000? No, no. We killed 38,000.” Thomas L. Friedman, *From Beirut to Jerusalem* (New York: Farrar, Straus, Giroux, 1989), 90. This must-read book about the Levant won the National Book Award in 1989.

10. Ibid., 91.

11. “We Can't Win Media War with West but It's Not Battle That Counts,” Autonomous Nonprofit Organization (“TV-Novosti”), 17 May 2012, <http://rt.com/news/syria-media-battle-assad-429/>. Al-Assad has repeatedly described the FSA “as a crowd of convicted criminals, comprised among other things of Al-Qaeda type religious fanatics, extremists and terrorists and to some extent of foreign mercenaries, predominantly from other Arab states” (ibid.) Some FSA members are in fact hard-line Islamists, but the vast majority have no affiliation with al-Qaeda.

12. Friedman, *From Beirut to Jerusalem*, 91. Friedman eerily brings up this point during the Muslim Brotherhood revolt decades earlier. This premise is further reinforced today through the lukewarm embrace of the FSA by some Sunni, Kurdish, and Christian factions. Throughout the “Arab Spring” and other times in Middle East history, when an autocratic regime is overthrown, the minority groups tend to find themselves at risk—take, for example, the recent plight of the Coptic Christians in Egypt.

13. Thomas Hobbes (1588–1679) was an English philosopher and political theorist best known for his book *Leviathan* (1651), in which he argues that one can secure civil society only through universal submission to the absolute authority of a sovereign.

14. *Wikipedia: The Free Encyclopedia*, s.v. “Timeline of the Syrian Civil War (January–April 2011)” [see “6 March”], [http://en.wikipedia.org/wiki/Timeline_of_the_Syrian_civil_war_\(January%E2%80%93April_2011\)#15_March_.E2.80.93_.22Day_of_Rage.22](http://en.wikipedia.org/wiki/Timeline_of_the_Syrian_civil_war_(January%E2%80%93April_2011)#15_March_.E2.80.93_.22Day_of_Rage.22). For a video of the Day of Rage, see “Syrian Revolution, Syria,” YouTube video, posted 15 March 2011, <https://www.youtube.com/watch?v=75Ng0J6DdH0>.

15. Anne Sinai and Allen Pollack, eds., *The Syrian Arab Republic: A Handbook* (New York: American Academic Association for Peace in the Middle East, 1976), 59.

16. During World War I, Deraa—a vital crossroad of the Jerusalem-Haifa-Damascus-Medina railroads—was the scene of the Ottoman Turks' torture of T. E. Lawrence, also known as Lawrence of Arabia. T. E. Lawrence, *The Seven Pillars of Wisdom* (New York: G. H. Doran, 1926).

17. The Aleppo-to-Damascus route is no stranger to Muslim conflict and misery. The schism between Shiites and Sunnis was embodied during the battle of Karbala (680 CE) in present-day Iraq, where Muhammad's grandson Imam Hussein and 70 followers were killed by Yazid I, a Damascus-based ruler. The anniversary of the defeat is now known as "Ashura," a holy day of fasting and prayer, in which Shiites commemorate the perceived abandonment of Hussein and his followers. Yazid, a traditional Sunni, ordered that the captured Karbala survivors, along with Hussein's head, be paraded throughout the region. After a brief stop in Mosul, the procession traveled from Aleppo, south to Homs, and finally ended in Damascus. See Andrew Tabler, *In the Lion's Den: An Eyewitness Account of Washington's Battle with Syria* (Chicago: Lawrence Hill Books, 2011), 170.

18. Dr. Radwan Ziadeh, "The Battle for Syria" (lecture, School of Advanced International Studies, Johns Hopkins University, 30 November 2012), <http://mms.tveyes.com/Transcript.asp?StationID=200&DateTime=12%2F3%2F2012+12%3A21%3A12+PM&Term=washington+institute+for+near+east+policy&PlayClip=TRUE>.

19. Joseph Holliday and Christopher Harmer, *Syrian Air Force and Defense Overview* (Washington, DC: Institute for the Study of War, 25 October 2012), <http://www.understandingwar.org/press-media/graphsandstat/syrian-air-force-air-defense-overview>. Mr. Holliday, a former US Army intelligence captain with extensive experience in the Middle East, is an analyst at the Institute for the Study of War—a nonpartisan, nonprofit public-policy research organization. One of the first people to document and track the use of Syrian airpower against civilians, he founded and led a diverse interagency problem-solving group of diplomatic, military, intelligence, and Syrian experts.

20. Eddie Boxx and Jeff White, "Responding to Assad's Use of Airpower in Syria," Policywatch 1999, Washington Institute for Near East Policy, 20 November 2012, <http://www.washingtoninstitute.org/policy-analysis/view/responding-to-assads-use-of-airpower-in-syria>.

21. Ibid.

22. David Axe, "Danish Architect Maps Every Plane, Helicopter Shot Down by Syrian Rebels," *Wired*, 19 October 2012, <http://www.wired.com/dangerroom/2012/10/mapping-syrian-air-war>.

23. Information garnered through YouTube videos. Although unable to verify these facts independently, the author established a link between those aircraft engagements and sieges of air bases.

24. Jeffrey White, "Syria's Internal War Turns against the Regime," Policywatch 1996, Washington Institute for Near East Policy, 13 November 2013, <http://www.washingtoninstitute.org/policy-analysis/view/syrias-internal-war-turns-against-the-regime>.

25. Anne Barnard, "As Killings Go On, Syria Reacts Strongly to War-Crimes Petition," *New York Times*, 19 January 2013, <http://www.nytimes.com/2013/01/20/world/middleeast/syria-war-developments.html?ref=syria&r=0>.

26. In addition to conventional media coverage, YouTube videos uploaded by both regime and rebel forces as well as anti-Assad reporting by the British-based Syrian Observatory for Human Rights, local coordination committees, and nongovernmental organizations provided extensive documentation of events as they occurred.

27. Forum, Brookings Institution, subject: “Syria: The Path Ahead,” 8 November 2012. Mike Doran, the Roger Hertog Senior Fellow in the Saban Center for Middle East Policy at Brookings, and Salman Shaikh, director of the Brookings Doha Center, shared their views during the forum. Shaikh’s recent paper *Losing Syria (and How to Avoid It)* was a focus of the discussion, moderated by Daniel L. Byman, Senior Fellow and Research Director of the Saban Center for Middle East Policy.

28. These findings were presented and adopted on 12 October 2012 at the Syrian Project working group hosted by the Institute for the Study of War (ISW) and chaired by Joseph Holliday. The panel consisted of Human Rights Groups; nongovernmental organizations; personnel from the State Department, Department of Defense, and intelligence community; Syrian think-tank experts; and congressional staffers. The data came from two sources—YouTube videos of air strikes and the Syrian Observatory for Human Rights. The graphs show rotary versus fixed wing over time. The “bin size” is one day (i.e., each bar represents a day), and the data does not account for time of day—only the 24-hour period during which an air strike occurred. The instances that the ISW identified as aircraft against rebel positions proceeded from the following analysis: If ground combat occurred between rebels and regime forces in the same location and on the same date as air strikes, then the latter targeted rebels directly. If no FSA activity occurred and if air strikes were corroborated by other sources, then civilians were the intended targets. Certainly not every air strike that harmed civilians was intentional; the regime lacked precision-guided munitions and accurate targeting data. But by examining regime-posted videos and other evidence, one may reasonably conclude that it waged an air campaign against civilians. For this and more amplifying data on the air strikes, see Holliday and Harmer, *Syrian Air Force and Defense Overview*.

29. Oliver Homes and Shaimaa Fayed, “Syria Undecided on Ceasefire Proposal, Rebels Divided,” Reuters, 24 October 2012, <http://www.reuters.com/article/2012/10/24/us-syria-crisis-idUSBRE88J0X720121024>.

30. Holliday and Harmer, *Syrian Air Force and Defense Overview*; issues of *Scramble*, accessed 1 February 2013, <http://www.scramble.nl/sy.htm>; and the International Institute for Strategic Studies, *The Military Balance 2011* (Washington, DC: International Institute for Strategic Studies, 2011), 331.

31. “Syrian Colonel ‘Defects’ in Jet to Jordan,” *Guardian*, 21 June 2012, <http://www.guardian.co.uk/world/middle-east-live/2012/jun/21/egypt-election-result-delay-coup-live>.

32. “Russia Will Not Deliver Yak-130 Fighter Jets to Syria,” *Airforce-technology.com*, 9 July 2012, <http://www.airforce-technology.com/news/newsrussia-syria-fighter-jet-delivery>.

33. Jeff White, Washington Institute for Near East Policy, interview by the author, 29 November 2012 (expert opinion based on YouTube video of Fitter, posted 16 November 2012, http://www.youtube.com/watch?v=n5f5mjpVSEk&feature=player_embedded).

34. Boxx and White, “Assad’s Use of Airpower.”

35. *Ibid.*

36. “FSA Targeting al-Assad Regime Air Bases—Sources,” *Asharq Alawsat*, 7 December 2012, <http://www.asharq-e.com/news.asp?section=1&id=32082>.

37. Boxx and White, “Assad’s Use of Airpower.”

38. Joby Warrick, “Missiles Boost Rebels’ Arsenal,” *Washington Post*, 29 November 2012, A1, <http://thewashingtonpostnie.newspaperdirect.com/epaper/viewer.aspx>.

39. Babak Dehghanpisheh, "Syrian Rebels Take Two Military Bases in Heavy Fighting," *Washington Post*, 28 November 2012, 13, http://articles.washingtonpost.com/2012-11-27/world/35509205_1_syrian-rebels-military-bases-aleppo.

40. YouTube video, posted 16 January 2013, http://www.youtube.com/watch?feature=player_embedded&v=y5jsI739NRw.

41. Capture of the Damascus airport, the busiest one in the country and an important hub in the region, would have great significance. Damascus is served by more than 40 passenger and cargo airlines from across the Middle East, Europe, Africa, and the Commonwealth of Independent States, averaging over 4.5 million passengers annually. Ever since World War II, American forces have seen the strategic value of quickly seizing airfields. For example, the 3rd Infantry Division's capture of the Baghdad International Airport in 2003 signaled to the world that the United States had won the tactical fight for the city.

42. Jeffrey White, "Last Act in Damascus," Washington Institute for Near East Policy, 11 December 2012, <http://www.washingtoninstitute.org/policy-analysis/view/last-act-in-damascus>.

43. David E. Sanger and Eric Schmitt, "U.S. Weighs Bolder Effort to Intervene in Syria's Conflict," *New York Times*, 28 November 2012, 1, http://www.nytimes.com/2012/11/29/world/us-is-weighing-stronger-action-in-syrian-conflict.html?_r=0.

44. "Russians Flee Syrian Conflict on Planes from Beirut," BBC, 22 January 2013, <http://www.bbc.co.uk/news/world-middle-east-21140041>.

45. Bassel Oudat, "Airport Battles in Syria," *Al-Ahram Weekly*, 6 December 2012, <http://weekly.ahram.org.eg/News/497/19/Airport-battles-in-Syria.aspx>. Throughout the conflict, even with documented video footage, verifying the number of rebel claims of aircraft kills has been difficult. Compiled videos, however, suggest that the century mark seems a realistic number of total Syrian aircraft damaged in combat.

46. As part of the Syrian Missile Database Project at the Washington Institute for Near East Policy, a team daily searches YouTube videos and other media posted by the FSA and Syrian air force for Scud or other surface-to-surface missile launches. Media reports sometimes use the term *Scud* interchangeably to describe all surface missiles, so the goal is to determine the exact type of missile employed. Information documented includes launcher type, number of launches, launch origin, target location, type of missile, and type of target. With the help of meteorologist Capt Brian Yates, USAF, the team examines missile launches in the context of Syrian weather to identify whether regime forces use missiles rather than aircraft during inclement weather or whether they use them in desperation. At this time, not enough complete data exists to make an assertive conclusion; thus, the research project remains ongoing. Using YouTube videos of missile attacks, the Washington Institute for Near East Policy has tentatively identified and registered missile attacks. It observes that Scuds are transported on wheeled launcher vehicles and launched vertically (usually white in color and large) with a significant prelaunch smoke (perhaps due to liquid propellant)—basically upgraded 1944 V-2 Nazi rockets. In contrast the Fateh-110s are darker in color (tan or olive drab) than the Scud missiles and are essentially rockets on wheeled launchers with an SA-2 rails system. Thus they need to be fired at a pronounced angle (note that the rail remains after missile launches), much like oversized "bottle rockets." The SS-21 is also a non-white missile transported on a six-wheeled vehicle launcher, but it does *not* leave behind a rail after launch and goes vertical soon thereafter.

47. Andrew J. Tabler, Jeffrey White, and Aaron Y. Zelin, "Fallout from the Fall of Tافتهاناز," Policywatch 2015, Washington Institute for Near East Policy, 14 January 2013, <http://www.washingtoninstitute.org/policy-analysis/view/fallout-from-the-fall-of-tافتهاناز>.

48. Dr. Robert Satloff, director of the Washington Institute for Near East Policy for the last 20 years, has explained on multiple occasions the misnomer of an *Arab Spring* and why the Arabic term *intifada* better represents the unrest in the Middle East. I am much indebted to his extensive knowledge of the region and his willingness to explain a very complicated yet important area of the world.

49. Through the efforts of the Washington Institute for Near East Policy and the support of Syrian expert Andrew Tabler (author of *In the Lion's Den* [see note 17], another must-read book on Syria), the author has gained significant insight into the opposition by meeting with Syrian opposition leaders and an FSA member (opposition names withheld for security reasons).



Lt Col S. Edward Boxx, USAF

Lieutenant Colonel Boxx (BA, University of Texas–El Paso; MS, Embry-Riddle Aeronautical University; MA, Air University) is a Visiting Defense Fellow at the Washington Institute for Near East Policy. Previously he directed the air component coordination element for Joint Interagency Task Force South in Key West, Florida, where he was responsible for integrating Air Force assets to counter aerial and maritime smuggling operations. A veteran combat air battle manager, he has qualified in both the E-3 AWACS and E-8 JSTARS aircraft. Lieutenant Colonel Boxx has logged 1,500 combat and combat-support hours in the Middle East in support of air operations in Yemen, Turkey, Saudi Arabia, Iraq, and Afghanistan. While deployed in 2006 in support of Operation Iraqi Freedom, he participated in aerial operations against the smuggling and employment of improvised explosive devices. He also flew missions in support of the northern and southern no-fly zones in Iraq in the 1990s. A graduate of Squadron Officer School and Air Command and Staff College, Lieutenant Colonel Boxx has published numerous airpower articles.

Let us know what you think! Leave a comment!

Distribution A: Approved for public release; distribution unlimited.

Disclaimer

The views and opinions expressed or implied in the *Journal* are those of the authors and should not be construed as carrying the official sanction of the Department of Defense, Air Force, Air Education and Training Command, Air University, or other agencies or departments of the US government.

This article may be reproduced in whole or in part without permission. If it is reproduced, the *Air and Space Power Journal* requests a courtesy line.

<http://www.airpower.au.af.mil>

Cataclysm: General Hap Arnold and the Defeat of Japan by Herman S. Wolk. University of North Texas Press (<http://untpress.unt.edu/>), 1400 Highland Street, Stovall Hall, Room 174, Denton, Texas 76201, 2010, 352 pages, \$24.95 (hardcover), ISBN 9781574412819.

Herman S. Wolk, senior historian of the Air Force, now deceased, examines the legacy of Gen Hap Arnold in his book *Cataclysm*, an analysis of Arnold's role in the strategic bombing campaign that led to Japan's surrender in 1945. With the creation of Twentieth Air Force, the general laid the foundation for a postwar strategic Air Force. Commanded by Arnold himself and reporting directly to the Joint Chiefs of Staff, the Twentieth flew B-29s that operated first from China and then the Mariana Islands, overcoming numerous technical and operational obstacles to play a decisive role in ending the Pacific war. Wolk credits this achievement to Arnold's drive and determination, which helped establish the Air Force not only as an independent service but also as the nation's premier strategic deterrent force in the postwar period.

Cataclysm clearly shows that Arnold himself never claimed that strategic bombing was the sole determinant of victory, but he did believe that a combination of bombing and naval blockade would defeat Japan without the need for either an invasion or the use of atomic weapons. The author describes Arnold's struggle to get the B-29 ready for operational employment despite numerous technological problems, his success at establishing Twentieth Air Force as an independent command, and his willingness to replace Haywood Hansell with Curtis LeMay as an operational commander when the bombing campaign initially produced disappointing results. LeMay's shift from high-altitude daylight precision bombing to nighttime low-altitude area bombing that employed incendiaries against Japan's highly flammable cities had the desired effect: destruction of urban industry and a downward spiral in civilian morale. This bombing offensive, combined with strikes by carrier aircraft, gunfire from warships, submarine attacks on Japanese shipping, and a mining campaign in which the Army Air Forces played a significant part, brought Japan to the brink of destruction.

Would Japan have surrendered if the United States had not dropped atomic bombs or if the Soviet Union had not entered the Pacific war? Was the targeting of civilians in firebombing raids necessary when maritime isolation had already largely ruined Japan's economy? Did Twentieth Air Force's late entry into the war against Japan justify the Air Force's postwar claims to strategic primacy among the nation's armed services? The author touches on these questions but does not squander ink on counterfactual arguments that are ultimately counterproductive. A variety of factors contributed to Japan's defeat, and *Cataclysm* clearly demonstrates that strategic bombing was one of them.

Hap Arnold had the determination to win the administrative battles that gave Airmen the weapons and organization they needed to contribute to victory. He also had the vision to lay a foundation for the future by creating an independent Air Force and preparing for the technological challenges that future might bring. Wolk notes Arnold's recruitment of Dr. Theodore von Kármán to lead a team of scientists in the compilation of lengthy reports entitled *Where We Stand* and *Toward New Horizons*. As the author also observes,

Arnold emphasized that he did not "hold any brief" for a permanent Air Force. It was conceivable, he said, that a mighty Air Force, like that employed in World War II, would no longer be required. However, a well-trained, fully equipped force able to use the new technology would be needed. Most importantly, and following von Karman's prescription, the nation required a dynamic, well-financed research and development program: "If we fail to keep not merely abreast, but ahead of, technological development, we needn't bother to train any force and we needn't make plans for an emergency expansion: we will be totally defeated before any expansion could take place" (p. 236).

In 2011 the Air Force chief of staff selected this well-written and thoroughly researched book for inclusion in his professional reading list. I highly recommend *Cataclysm* to students and scholars of World

War II as well as the Air Force community as a whole. It should be available in the professional reading section of base libraries.

Frank Kalesnik, PhD

*Air Force Research Laboratory History Office
Wright-Patterson AFB, Ohio*

Navy Strategic Culture: Why the Navy Thinks Differently by

Roger W. Barnett. Naval Institute Press (<http://www.usni.org/store/books>), 291 Wood Road, Annapolis, Maryland 21402, 2009, 256 pages, \$28.95 (hardcover), ISBN 1591140242.

In *Navy Strategic Culture*, Roger Barnett argues that the Navy has a superior strategic mind-set that comes from a unique strategic culture. This culture includes an appreciation of technology as a force multiplier and the intense male bonding produced by the isolation of naval service in the uniquely hostile oceanic environment. This combination produces an aggressive Navy that establishes sea control and power projection through a focus on expeditionary operations (pp. 59–73).

In addition to establishing a clear and provocative thesis, Barnett does a good job of presenting the Navy's operational philosophy toward warfare. He provides a concise, comprehensive, and informative outline of the legal, political, social, economic, and environmental context in which the Navy operates. The best part of his work addresses the unique relationship between the Sailor and the open seas; he paints a vivid picture of how the precarious and isolated nature of naval service is essential to the Navy's cultural makeup (pp. 13–17).

Ultimately, however, the author fails to make the case that the Navy's strategic culture is unique to the service or that it creates an organization with a broader, more nuanced strategic mind-set than any other group in the United States. In fact, the Navy's solitary, insular operations stand as an obstacle to broad strategic thought—far more so than the operations of any other service. Strategy requires a holistic appreciation of the larger geopolitical context—an understanding of the rela-

tionship between achieving the higher political object with the means at one's disposal. It is hard to see how Barnett's hermit-like Navy could develop a finer appreciation for the broader social, political, and economic contexts that frame the conditions under which military force must be hammered into an instrument that can realize specific geopolitical goals. Naval strategic culture appears predisposed to nourish a narrow parochial perspective. That is precisely the book Barnett gives us. His emphasis on the distinctive role of technology in naval culture is also suspect. The Navy's technical focus is not a specific cultural virtue of that service but a value that comes from American society and extends to the entire military.

At one point the author asserts that, given the Navy's self-sufficiency, it is perfectly acceptable for that service to take a lax attitude toward jointness. Indeed, he believes that apathy may actually be a good thing if jointness leads to the homogenization of naval strategic culture (pp. 107–8). In reality, knowing the requirements for winning the war and attaining political objectives is of primary importance. Since the Persian Gulf War, the Navy has had the principal role of serving as a facilitator of other services that bear the brunt of actual fighting. In light of the fact that Marines have conducted sustained operations inland and Air Force aircraft have flown the overwhelming majority of combat missions since 1991, winning demands a level of jointness transcending parochialism.

When Barnett observes that the Navy is best attuned to understanding the Iraqi insurgency because its nonlinear nature reflects “the migration over land of many of the characteristics of contemporary naval warfare” (p. 41), he makes the classic mistake of arguing that this conflict and terrorism represent a new form of warfare. Such a contention ignores a rich and storied history extending from the experiences of Alexander the Great through Vietnam—actions that represent the most overwhelmingly common form of conflict in the latter half of the twentieth century, consuming millions of lives.

Barnett's work assumes that a single way of war or "seek[ing] to use the *maximum force permissible* so that the conflict can be won as quickly as possible with the least amount of destruction and carnage" (emphasis in original) (p. 104) is most appropriate for all forms of conflict. However, insurgencies and low intensity conflicts are tactically indecisive, protracted, and frustrating, featuring no silver bullet. The author claims that Christian morality has led to restraint in the Iraq war and the war on terror; in reality, such constraints offer the best response to warfare involving an alien population as the center of gravity (pp. 112–16). He complains about the so-called pottery barn rule, maintaining that it unduly restricts the flexible application of military force (pp. 112–16). However, given Iraq's position as a leading supplier of petroleum reserves and the dangers of this state collapsing or becoming an Iranian client state, the United States had to impose order. The book also voices the misguided belief that in warfare one should always imprison many innocents if doing so captures even a handful of combatants. This practice, though, has consistently produced disastrous results throughout the history of unconventional warfare (pp. 104–6, 112–16). Widespread sweeps of all military-age males in Iraqi neighborhoods and their treatment at Abu Ghraib created numerous additional enemies for America. Strategic discrimination may help explain why the North Atlantic Treaty Organization has outlasted the unrestrained Soviets in Afghanistan at a fraction of the cost in casualties.

Of particular note is Barnett's approval of the Iraq war as a means of striking at the source of terrorism and its alleged state sponsors; he points to this action as an instance of agreement between government policy and naval strategic culture (pp. 104–6). However, we have known for many years that Saddam Hussein neither allied with nor supported al-Qaeda, that his program for producing weapons of mass destruction (WMD) had become moribund, that his regime was rotting away, and that he had no involvement in the terrorist attacks of 11 September 2001. From the perspective of striking at the source of the danger represented by terrorists armed with WMDs, attacking Iraq distracted from the war in Afghanistan and fuelled extremism. Finally,

there is something fundamentally wrong with a book that addresses naval strategy but never mentions China—a book which spills considerable ink on the grossly exaggerated premise that placing women on warships constitutes an irreversible disaster that will “feminize” and thus doom the Navy (pp. 116–21, 127–29).

Toby Lauterbach

Purdue University–West Lafayette

Fighting Talk: Forty Maxims on War, Peace, and Strategy by Colin S. Gray. Potomac Books (<http://www.potomacbooksinc.com/Books/Features.aspx>), 22841 Quicksilver Drive, Dulles, Virginia 20166, 2009, 208 pages, \$15.96 (softcover), ISBN 978-1-59797-307-6.

The distillation of some 40 years of scholarly work by one of the most prolific strategists of our time, *Fighting Talk* is an accessible collection of essays that briefly explores the vital assumptions of a working strategist and describes the building blocks of strategic theory. Making a repeat appearance on the Air Force chief of staff's reading list for 2012 with his more recently published *Airpower for Strategic Effect* (Air University Press, 2011), Gray is known for his scholarly depth and rigor. Although the illustrations in *Fighting Talk* are brief, the historical examples that support each maxim supply plenty of rigor. Some readers might criticize the lack of depth in this short essay format, but Gray's conscious purpose here is to cut to the chase. As he reminds us throughout the book, strategy is a practical pursuit.

Divided into five parts, the book begins with part 1, “War and Peace” (maxims 1–10), an aptly named wide-aperture look at the nature of war and the relationship between war and peace. Maxim 8, “There Is More to War than Warfare,” draws an important distinction between the state of relations among belligerents and the actual conduct of the fighting, whether by military or irregular forces. This difference is often lost or ignored in conversation but remains important to understand as the book moves through part 2, “Strategy” (maxims 11–21),

which Gray points to as the bridge between the political focus of part 1 and the military concerns of part 3.

In part 3, “Military Power and Warfare” (maxims 22–28), the focus narrows to the more pragmatic business of military performance with lessons from the operational, tactical, and logistical aspects of actually fighting the fight. It is not a checklist for campaign planning but a coherent set of reminders to provide a solid conceptual foundation to the war fighter. Throughout, this part reminds the reader that, though not conducted for its own sake, warfare nonetheless remains a vital part of the big picture of policy and politics. As maxim 26 makes clear, “Victory in Battle Does Not Ensure Strategic or Political Success, but Defeat All but Guarantees Failure.” Thus, we learn that even though we must always consider the forest, we can lose it if we fail to focus on the trees as well.

The first three parts deal with what Gray describes as the core concerns of the strategist, but the last two—part four, “Security and Insecurity” (maxims 29–35), and part 5, “History and the Future” (maxims 36–40)—step back again to provide contextualization about the nature, dynamic character, and functioning of world politics. One thread running through these last 12 maxims stresses the importance of understanding the past as a way of informing decisions about the future. This notion is captured in maxim 37, “History Can Be Misused to ‘Prove’ Anything, but It Is All That We Have as a Guide to the Future,” which argues that the strategist who disdains the past is left only with the present and the future—and the future cannot be known.

The reader should not expect any particularly profound revelations in *Fighting Talk*. Maxims, after all, are generally accepted truths—statements generally beyond controversy. Indeed, Gray openly admits that he really offers nothing new by asserting in maxim 14 that “If Thucydides, Sun-tzu, and Clausewitz Did Not Say It, It Probably Is Not Worth Saying.” This is not to say that the book is not worth the relatively short time required to read it. The real value in reading and contemplating the maxims is twofold. First, the individual essays can serve as a jumping-

off point for further reflection and study. Second, and perhaps even more important for those who “do” strategy, is the grounding that the entire collection provides for sound decision making.

Fighting Talk is not a prescriptive “how-to” guide for planning, fighting, and winning wars. Rather, it ably serves as a primer for politicians, war fighters, pundits, and the interested public to better understand the very nature of war, peace, and strategy and the way those three are intertwined. As Gray points out in his introduction, “these truths frequently are forgotten, or misunderstood, often with dire consequences” (p. xiii). Mistakes will always be made. By learning and applying the lessons of these enduring truths, however, practitioners of the strategic art can improve their chances that the significance of their failures is small rather than catastrophic.

Maj Stephen L. Meister, USAF

Offutt AFB, Nebraska

Breakthrough: The Gorlice-Tarnow Campaign, 1915 by Richard L. DiNardo. ABC-CLIO (<http://www.abc-clio.com/>), 130 Cremona Drive, Santa Barbara, California 93117, 2010, 215 pages, \$44.95 (hardcover), ISBN 978-0-275-99110-4.

Richard DiNardo’s book *Breakthrough* is a welcome and very insightful addition to the limited amount of literature on eastern front campaigns during World War One. Fought on 2–10 May 1915, Gorlice-Tarnow in many ways was the decisive battle on the eastern front. The so-called Polish salient gave Russia a chance to attack to the west into Imperial Germany and to the south into the Austro-Hungarian Empire. Germany and Austria-Hungary, however, could also attack and trap every Russian soldier in the salient. After the Imperial German Army had defeated the Russian attack on East Prussia, the Imperial Russian Army still occupied Poland and thus remained a threat to both Germany and the Austro-Hungarian Empire—the central powers in the conflict. The Austrians had suffered some setbacks and looked to their

German allies to help them stabilize the front near the Carpathian Mountains. Sensing that they could push the Russians back and use flanking movements to defeat the substantial Russian force, the Germans agreed. All of these events combined to make Gorlice-Tarnow one of the rare breakthrough battles of World War One.

The book touches on topics that the modern military reader will recognize, including coalition operations, air operations, and a lack of both sufficient forces and logistical support. The Germans and Austrians had to overcome differences at the general staff level before the German High Command and Gen Erich von Falkenhayn agreed to move four corps equaling eight divisions from the western front to Gorlice at the edge of the Carpathians, linking them to Tarnow. The new German 11th Army, formed under Gen August von Mackensen, included the German formations, an Austrian corps, and a Hungarian cavalry division—the first joint command in the war. More operations like this one would follow later in the war, as Germany became the senior partner in the coalition. Because of high casualties, Austria slipped into a junior role.

The Germans, who possessed more aircraft than the Russian Air Service, took advantage of both aerial reconnaissance, which allowed German commanders to see and track Russian movements on the battlefield, and artillery spotting. Since the Germans' heavy guns suffered from a shortage of artillery shells, spotting allowed them to make each shell count. These two aspects of airpower permitted the German and Austrian attackers to use large-caliber guns (more than 150 millimeters) to obliterate Russian strongpoints.

Able to exploit openings, the Germans ripped into the front line and quickly advanced into the Russian rear, turning the front relatively quickly. Making rapid progress, they threatened the entire Russian Carpathian front. Ordering a full retreat out of Poland, the Russians attempted to consolidate their positions, and by the middle of September 1915, they had fallen back to a line that ran from the Lithuanian to the Romanian border.

In *Breakthrough*, DiNardo paints a vivid picture of the casualties that the German army units had to absorb and the effect of hard campaigning, forced marches, and nighttime repositioning. The book's exploration of individual encounters allows the reader to follow the progress of the various battles. Unfortunately, the author includes little numerical data regarding the use of airpower to show the level of effort in reconnaissance, spotting, and bombardment. Nevertheless, I highly recommend this excellent text on operational art to both strategists and historians interested in World War One.

Gilles Van Nederveen

Fairfax, Virginia

Terrorism, Instability, and Democracy in Asia and Africa by

Dan G. Cox, John Falconer, and Brian Stackhouse. Northeastern University Press (University Press of New England) (<http://www.upne.com/northeastern.html>), 1 Court Street, Suite 250, Lebanon, New Hampshire 03766, 2009, 244 pages, \$60.00 (hardcover), ISBN 978-1-55553-705-0.

Today, when terrorism seems to strike almost daily and when terrorist acts occur in formerly untouched countries, we must ask ourselves how we can prevent such acts, what causes people to commit them, and what their purpose is. *Terrorism, Instability, and Democracy in Asia and Africa* seeks to answer those critical questions.

The authors designed this analytical work primarily for individuals who study politics and terrorism as well as for policy makers who desire a greater understanding of the nature and ends of terrorism. Although the book may seem weighted more toward political use, it has significant value to readers in any field of study or to those curious about the rise of terrorism.

With regard to how and why terrorism occurs, Cox, Falconer, and Stackhouse first address the definition of the term. The lack of a concise delineation, however, creates difficulty in apprehending the con-

cept (i.e., insurgency in one country is terrorism in another; freedom fighters in one country are terrorists in another) and in establishing international laws to fight it. Is terrorism an illegal act? Are the instigators addressing a perceived wrong or trying to bring down a regime to establish their own? Are the targets military or political establishments or areas where people going about their business might be killed or injured? Do terrorists wish to right a wrong or pressure the government into changing a policy? If the international community has no formal understanding of terrorism, how can we combat it?

According to the authors, we may look for the origins of terrorism in a number of areas, including democracy, the history of a civilization, poverty, and a country's political, cultural, economic, or historical instability. This milieu determines whether or not terrorism arises, its ability to bring about change in established institutions, sources for recruiting terrorists (e.g., from the middle class, lower middle class, etc.), its economic effects, and whether or not a country's history of stability ultimately helps or hampers the development of terrorism.

In addition to examining these factors in detail, Cox, Falconer, and Stackhouse offer a number of case studies to illustrate the influence of such variables on areas like the Middle East, Africa, the Near East, and the Far East. Each of these regions has dealt with terrorism for years, even decades. The text examines how their governments have chosen to deal with it (by means of violence, a carrot-and-stick approach, compromise, etc.) and explores whether those actions have lessened, neutralized, or possibly increased terrorist activity.

In a work of this type, the credibility of the authors and the data assumes considerable importance. Cox, Falconer, and Stackhouse concisely present information, citing sources that both support and oppose their positions. The only flaws worthy of mention entail the frequent use of relatively unfamiliar abbreviations and the inclusion of an unnecessary chapter devoted to investigative methods applied to terrorism. Admirably, the authors assume a neutral, balanced stance

with regard to their data and the use of case studies, thereby enhancing the credibility of the text.

Readers will find *Terrorism, Instability, and Democracy in Asia and Africa* easy to read and understand. The case studies, which are fairly short and to the point, effectively depict how and why terrorism arises and suggest ways of dealing with it. I recommend that all military personnel read and study this book carefully.

Mel Staffeld
Council Bluffs, Iowa

Confronting the Chaos: A Rogue Military Historian Returns to Afghanistan by Sean M. Maloney. Naval Institute Press (<http://www.usni.org/store/books>), 291 Wood Road, Annapolis, Maryland 21402, 2009, 384 pages, \$34.95 (hardcover), ISBN 1591145082.

In *Confronting the Chaos*, Dr. Sean Maloney presents a detailed account of his travels in Afghanistan from 2003 to 2005. The author currently serves as historical adviser to the Canadian Army's chief of the land staff and as an associate professor of history at the Royal Military College of Canada. His experiences in academia and as a historian embedded with Canadian military units during the Cold War provide a unique perspective that has surely contributed to the production of this high-quality work. Maloney's factual accounts of events and his unique sense of humor create an interesting and entertaining book that offers a glimpse into complex aspects of the Afghanistan conflict with which many people are not familiar.

The author argues that "Afghanistan . . . is not and will never be Iraq . . . and it must be understood on its own terms" (p. 144). He defends this position by using his own travels in Afghanistan as a backdrop to introduce the complex works of a few lesser-known but hugely important organizations involved in the conflict there. The book's six parts help the reader better understand the war in Afghanistan. The first three lay the foundation, with part 1 detailing the organization of the

war in 2003 and the unique division of responsibilities between the coalition forces supporting Operation Enduring Freedom and the International Security Assistance Force (ISAF). Parts 2 and 3 relate Maloney's experiences in Kabul during 2004, providing an excellent synopsis of the ISAF's evolution and the early development of the provincial reconstruction team (PRT).

Although the first three parts are very informative, the book really shines in the remaining three. Much like part 1, part 4 gives readers the background they need to comprehend topics introduced in subsequent portions of the book. Here we first witness the evolution of the organizational structure of Enduring Freedom and the growth of the ISAF. Parts 5 and 6 again focus on the author's travels, this time emphasizing the strategic assessment team in Kabul and the Canadian PRT in Regional Command South. He offers distinctive insight into the development, coordination, and reconstruction essential to success or failure in the Afghanistan campaign. Additionally, this portion of the book delves into the complicated tribal relationships and security challenges that constantly inhibit progress in that country.

One should note that the bulk of the analysis addresses the work of the Canadian PRT in Regional Command South. Although he considers this area one of the most critical in the conflict, Dr. Maloney devotes about half of the book to people and events associated with that command. This emphasis creates an unbalanced feel, leaving the reader with less than a complete understanding of the efforts of PRTs in other areas. However, this imbalance does not detract from the overall quality of the study.

Confronting the Chaos: A Rogue Military Historian Returns to Afghanistan certainly meets its objectives. By recounting his experiences and writing a useful, informative examination of the war in Afghanistan, Dr. Maloney has established a high standard for future chroniclers of this conflict. Historians will appreciate his account of the evolution of the discord in this country and his comparisons and contrasts to other conflicts. Individuals interested in foreign affairs, security, or develop-

ment will enjoy his explanation of the function of the PRTs and the strategic advisory team. This book should be mandatory reading for anyone interested in the nature of the struggle in Afghanistan.

Capt William R. Giles, USAF
Southwest Asia

Bully Able Leader: The Story of a Fighter-Bomber Pilot in the Korean War by Lt Gen George G. Loving, USAF, Retired. Stackpole Books (<http://www.stackpolebooks.com/>), 5067 Ritter Road, Mechanicsburg, Pennsylvania 17055, 2011, 256 pages, \$24.95 (hardcover), ISBN 9780811710268.

I've read and reviewed many accounts of the operational experiences of pilots and units dedicated to the task of supporting ground operations. Most of these stories were set in World War II, but, surprisingly, every author had unique experiences—a fact that indicates the rich tapestry and vastness of the war. Such was the case with George Loving, who wrote about his time in Italy in *Woodbine Red Leader* (Presidio Press, 2003). He began flying ground-support missions there but eventually transferred to P-51s, spending the rest the war as an escort pilot. Loving flew 151 combat missions and became an ace by shooting down at least five enemy planes. His second venture into combat occurred during the Korean conflict.

Soon after the end of the war in Europe, the Army Air Forces sent him to Japan; his new bride followed him when housing facilities became available. Like any sensitive autobiographer, Loving offers accounts of his life in the Far East, giving readers an idea of that area's culture and the changing attitudes toward the Japanese and, later, the Russians (the latter quite active in China and the northern reaches of Korea). He also describes his working conditions—those typical of a young officer involved in the grind of necessary support jobs, such as those dealing with personnel issues. In a couple of months, after moving back to the States, Loving was called back to the Far East and Ko-

rea—this time almost completely in air ground-support operations. (To my knowledge, *Bully Able Leader* is the first autobiography that includes fighter-bomber exploits. Consequently, nearly everything in it differs from the World War II narratives familiar to me.)

Loving clearly describes the air-support operations that involved F-51s flying against the North Korean army as it pressed close to the Pusan Perimeter in the lower west coast of Korea. Remaining at his base in Taegu, known as “K-2” by Far East Air Forces, he found himself running a small cadre. Because enemy troops were closing in, the base essentially had been abandoned, retaining only enough personnel to fuel and arm aircraft still flying support against advancing enemy troops—and to respond to emergencies.

The author survived that scare, and circumstances improved after Gen Douglas MacArthur orchestrated the daring amphibious raid at Inchon that promised to cut North Korean forces in half. With the enemy on the run, air leaders began rapid construction of bases as close to the front as possible so that the allied armies could receive air support quickly. Loving describes the military situation and rapid influx of fighter and medium bomber wings to the new bases, demonstrating a good eye for detail about fighting a war in Korea. Employed in base operations—still at K-2 in southeast Korea—he relates the efforts outside actual combat that ensure an effective air force, relating firsthand experiences as well as the views of colleagues at other bases. No one has ever painted such a clear picture of the air-support side of Korean airpower.

Again, Loving masterfully describes the progress of the war and the living conditions on bases, as well as his temporary service as a forward air controller living with ground forces. The heart of the second half of the book, flying in support of the army, superbly chronicles the many close-support and interdiction missions—dangerous business, whether in an F-51 Mustang or the new F-80 Shooting Star. From 25 January to 16 February 1951, the author flew every day but one; twice

he flew two missions in a day—some close air support and some interdiction against bridges and road traffic.

He had close calls when the enemy shot holes in his plane, but the repetition of missions brought out a feeling of sameness. Nonetheless, he declared that the “potential hazards precluded a relaxed approach” (p. 138). Action and accidents claimed some of Loving’s friends; he comments that “losses were expected and stoically accepted. No overt mourning of a loss took place, and little discussion . . . beyond superficial comments about how good a guy he was” (p. 143). The author gives readers insight into the controlled emotions necessary to accept losses and the continuing hazards of fighting a tough enemy.

Loving carefully crafts his accounts of months of combat, ending in June 1951 when he had completed 112 missions. Receiving orders to go home, he proclaimed his satisfaction with serving as a successful squadron leader in combat—an opportunity available to only a few—and his delight at having survived.

Bully Able Leader will please Airmen of all ranks and ages. It is an Airman’s story—well told, entertaining, educational, and purposeful.

Dr. Dan Mortensen
Air Force Research Institute
Maxwell AFB, Alabama

Let us know what you think! Leave a comment!

Distribution A: Approved for public release; distribution unlimited.

Disclaimer

The views and opinions expressed or implied in the *Journal* are those of the authors and should not be construed as carrying the official sanction of the Department of Defense, Air Force, Air Education and Training Command, Air University, or other agencies or departments of the US government.

These book reviews may be reproduced in whole or in part without permission. If they are reproduced, the *Air and Space Power Journal* requests a courtesy line.

<http://www.airpower.au.af.mil>